



河北千力橡胶制品有限公司

胶管接头

FERRULES & HOSE FITTINGS



## 目录 (catalogue)

型 号 REFERENCE	描述 DESCRIPTION	页数 PAGE
01100	FERRULE FOR CHINA1-WIRE HOSE	2
01200	FERRULE FOR CHINA2-WIRE HOSE	2
01300	FERRULE FOR CHINA3-WIRE HOSE	3
01400	FERRULE FOR R12/20-24& 'FEIYU' 4-SPIRAL HOSE	3
00100	FERRULE FOR SAE 100R1AT/DIN20022 1ST HOSE	4
00110	FERRULE FOR SAE 100RIAT/DIN20022 1SN HOSE	4
00110-A	FERRULE FOR SAE 100RIAT/DIN20022 1SN HOSE	5
00200	FERRULE FOR SAE 100R2AT/DIN20022 2ST HOSE	5
00210	FERRULE FOR SAE 100R2AT/DIN20022 2SN HOSE	6
03310	FERRULE FOR SAE 100R2AT/DIN20022 2SN HOSE	6
00400	FERRULE FOR 4SP、4SH/10-16、R12/06-16 HOSE	7
00401	FERRULE FOR R12/20-24 HOSE	7
00018	FERRULE FOR SAE 100R7 HOSE	8
00TFO	FERRULE FOR TEFLON HOSE	8
00500	FERRULE FOR SAE 100 R5 HOSE	9
00621	FERRULE FOR GB/T 10544 R13/SAE 100 R13/EN856 R13 HOSE	9
10311	O-RING METRIC MALE FLAT SEAT	14
20211 20211-T	METRIC FEMALE FLAT SEAT	15
20241 20241-T	45° METRIC FEMALE FLAT SEAT	16
20291 20291-T	90° METRIC FEMALE FLAT SEAT	17
10411	METRIC MALE 24° CONE SEAT L.T.	18
20411 20411-T	METRIC FEMALE 24° CONE O-RING L.T.	19
20411C	METRIC FEMALE MULTISEAL 24° CONE L.T.	20
20411C-T		
20441 20441-T	45° METRIC FEMALE 24° CONE L.T.	21
20491 20491-T	90° METRIC FEMALE 24° CONE O-RING L.T.	22
20491C	90° METRIC FEMALE 24° CONE MULTISEAL L.T.	23
20491C-T		23
10511	METRIC MALE 24° CONE SEAT H.T.	24
20511 20511-T	METRIC FEMALE 24° CONE O-RING H.T.	25
20511C	METRIC FEMALE 24° MULTISEAL H.T.	26
20511C-T		
20541 20541-T	45° METRIC FEMALE 24° CONE O-RING H.T.	27
20541C	45° METRIC FEMALE 24° MULTISEAL H.T.	28
20541C-T		
20591 20591-T	90° METRIC FEMALE 24° CONE O-RING H.T.	29
20591C	90° METRIC FEMALE 24° MULTISEAL H.T.	30
20591C-T		

# 目录 CATALOGUE

10611	METRIC MALE DOUBLE USE FOR 60°	31
20611 20611-T	METRIC FEMALE 60° CONE	32
20691 20691-T	90° METRIC FEMALE 60° CONE	33
10711	METRIC MALE 74° CONE	34
20711 20711-T	METRIC FEMALE 74° CONE SEAT	35
20741	45° METRIC FEMALE 74° CONE SEAT	36
20791	90° METRIC FEMALE 74° CONE SEAT	37
10811L	METRIC MALE 90° CONE	38
20111 20111-T	METRIC FEMALE MULTISEAL	39
20141 20141-T	45° METRIC FEMALE MULTISEAL	40
20191 20191-T	90° METRIC FEMALE MULTISEAL	41
50011	METRIC STANDPIPE STRAIGHT	42
50091	90° METRIC STANDPIPE STRAIGHT	43
51011	BSP STANDARD PIPE	44
51091	90° BSP STANDARD PIPE	45
NS NL	RETAINING NUT L.T.	46
12211	BSP MALE O-RING SEAL	47
12611	BSP MALE 60° CONE SEAT	48
12611A	BSP MALE DOUBLE USE FOR 60° CONE SEAT OR BONDED SEAL	49
22611 22611-T	BSP FEMALE 60° CONE	50
22611-W		
22611D	BSP FEMALE 60° CONE DOUBLE HEXAGON	51
22611D-SM	BSP FEMALE 60° CONE DOUBLE HEXAGON	51
22641 22641-T	45° BSP FEMALE 60° CONE	52
22641-W		
22691 22691-T	90° BSP FEMALE 60° CONE	53
22691-W		
22691K	BSP FEMALE CONE DOUBLE HEXAGON	54
22111 22111-T	BSP FEMALE MULTISEAL	55
22111-W		
22141 22141-T	45° BSP FEMALE MULTISEAL	56
22141-W		
22191 22191-T	90° BSP FEMALE MULTISEAL	57
22191-W		
13011-SP	BSP MALE	58
14211	ORFS MALE O-RING SEAL	59
24211 24211-T	ORFS FEMALE FLAT SEAT	60
24211-W		
24291 24291-T	90° ORFS FEMALE FLAT SEAT ISO 12151-1—SAE J516	61
24291-W		
15611	NPT MALE	62
16011	SAE O-RING SEAL	63
16711L	JIC 74° MALE CONE SEAL LONGER	64
16711	JIC 74° MALE CONE SEAL	65





## 目录 CATALOGUE

26711	JIC FEMALE 74° CONE SEAT	66
26741 26741W	45° JIC FEMALE 74° CONE SEAT	67
26791 26791W	90° JIC FEMALE 74° CONE SEAT	68
26791K	90° JIC COMPACT FEMALE 74° CONE SEAT	69
17811	SAE MALE 90° CONE	69
27811	SAE FEMALE 90° CONE SEAT	70
21611	NPSM FEMALE 60° CONE	71
87312	SAE FLANGE 3000 PSI	72
87342	45° SAE FLANGE 3000 PSI	73
87392	90° SAE FLANGE 3000 PSI	74
87392-H	90° SAE FLANGE SPECIAL HEIGHT	75
HALF	FL 3000 PSI HALF FLANGE	76
FLANGE	FS 6000 PSI HALF FLANGE	76
87612	SAE FLANGE 6000 PSI	77
87642	45° SAE FLANGE 6000 PSI	78
87692	90° SAE FLANGE 6000 PSI	79
18611	JIS METRIC MALE 60° CONE SEAT	80
28611 28611W	JIS METRIC FEMALE 60° CONE SEAT	81
28691 286912	90° JIS METRIC FEMALE 60° CONE SEAT	82
19611	JIS GAS FEMALE 60° CONE SEAT	83
29611 29611W	JIS GAS FEMALE 60° CONE SEAT	83
29691 29691W	90° JIS GAS FEMALE 60° CONE SEAT	84
88111	JIS FLANGE	85
88141	45° JIS FLANGE	85
88191	90° JIS FLANGE	86
20011-ST	METRIC FEMALE WATERWASH INSERTS 20011-ST	86
70011	METRIC BANJO	87
700M	METRIC BOLT	88
72011	BSP BANJO	89
720B	BSP BOLT	90
90011	DOUBLE CONNECTOR	90
90012	DOUBLE CONNECTOR	91

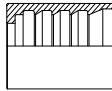
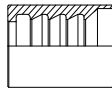
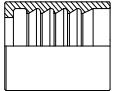

# 套筒 FERRULE

## 型号索引 (INDEX)

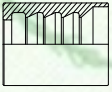
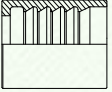
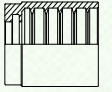
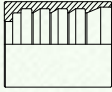
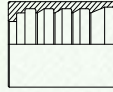
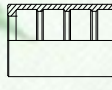
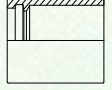
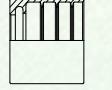
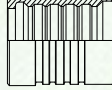
 01100	 01200	 01300	 01400	 00100	 00110
 00110-A	 00200	 00210	 03310	 00400	 00401
 00018	 00TF0	 00500	 00621		

# 套筒 FERRULE

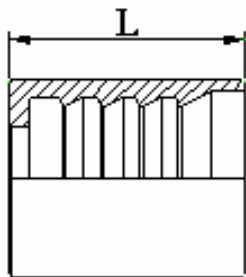

## 01100

国产一层编织胶管套筒  
FERRULE FOR CHINA1-WIRE HOSE

代号 PART NO.	胶管 HOSE BORE		尺寸 DIMENSIONS		
	公称内径 DN	标号 DASH		L	
01100-03	5	03		28	
01100-04	6	04		30	
01100-05	8	05		32	
01100-06	10	06		32	
01100-08	12	08		34	
01100-10	16	10		39	
01100-12	20	12		43	
01100-14	22	14		43	
01100-16	25	16		50	
01100-20	32	20		59	
01100-24	40	24		74	
01100-32	50	32		78	

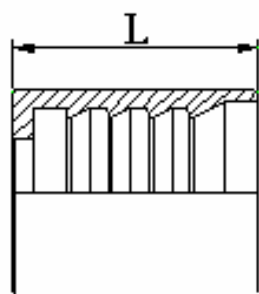

## 01200

国产二层编织胶管套筒  
FERRULE FOR CHINA2-WIRE HOSE

代号 PART NO.	胶管 HOSE BORE		尺寸 DIMENSIONS		
	公称内径 DN	标号 DASH		L	
01200-03	5	03		28	
01200-04	6	04		30	
01200-05	8	05		32	
01200-06	10	06		32	
01200-08	12	08		34	
01200-10	16	10		39	
01200-12	20	12		43	
01200-14	22	14		43	
01200-16	25	16		50	
01200-20	32	20		59	
01200-24	40	24		74	
01200-32	50	32		78	

套筒 FERRULE

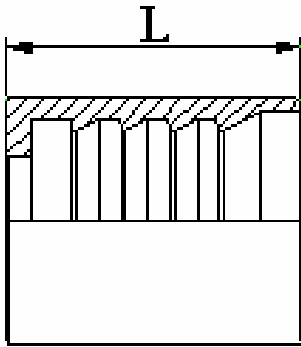

01300

国产三层编织胶管套筒  
FERRULE FOR CHINA3-WIRE HOSE

代号 PART NO.	胶管 HOSE BORE		尺寸 DIMENSIONS		
	公称内径 DN	标号 DASH		L	
01300-04	6	04		30	
01300-05	8	05		32	
01300-06	10	06		32	
01300-08	12	08		34	
01300-10	16	10		39	
01300-12	20	12		43	
01300-14	22	14		43	
01300-16	25	196		50	
01300-20	32	20		59	
01300-24	40	24		74	
01300-32	50	32		78	

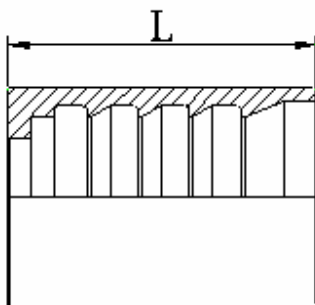

01400

R12/20-24 及国产四层钢丝缠绕胶管套筒  
FERRULE FOR R12/20-24 & 'FEIYU' 4-SPIRAL HOSE

代号 PART NO.	胶管 HOSE BORE		尺寸 DIMENSIONS		
	公称内径 DN	标号 DASH		L	
01400-04	6	04		37.5	
01400-06	10	06		39	
01400-08	12	08		41	
01400-10	16	10		43	
01400-12	20	12		51	
01400-14	22	14		54	
01400-16	25	196		61.5	
01400-20	32	20		67.5	
01400-24	40	24		75	
01400-32	50	32		79	

# 套筒 FERRULE

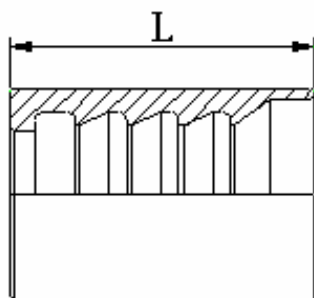

## 00100

SAE 100RIA/DIN20022 1ST 胶管套筒  
FERRULE FOR SAE 100R1AT/DIN20022 1ST HOSE

代号 PART NO.	胶管 HOSE BORE		尺寸 DIMENSIONS		
	公称内径 DN	标号 DASH		L	
00100-02	4	02		27	
00100-04	6	04		30	
00100-05	8	05		31	
00100-06	10	06		32	
00100-08	12	08		34	
00100-10	16	10		37	
00100-12	20	12		43	
00100-16	25	16		50	
00100-20	32	20		59	
00100-24	40	24		74	
00100-32	50	32		78	

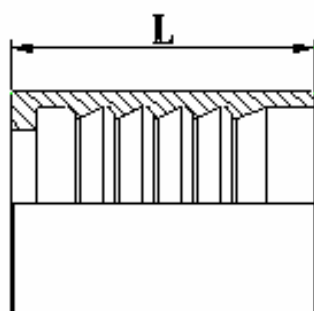

## 00110

SAE 100R1AT/DIN20022 1SN 胶管套筒  
FERRULE FOR SAE 100R1AT/DIN20022 1SN HOSE

代号 PART NO.	胶管 HOSE BORE		尺寸 DIMENSIONS		
	公称内径 DN	标号 DASH		L	
00110-03	5	03		24.5	
00110-04	6	04		30	
00110-05	8	05		31	
00110-06	10	06		32	
00110-08	12	08		34	
00110-10	16	10		37	
00110-12	20	12		43	
00110-16	25	16		50	
00110-20	32	20		59	
00110-24	40	24		74	
00110-32	50	32		78	



# 套筒 FERRULE

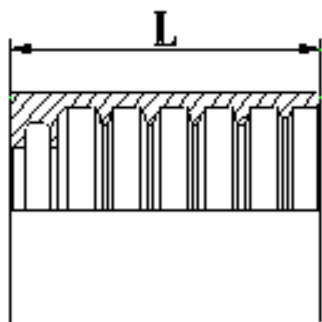

## 00110-A

SAE 100R1AT/DIN20022 1SN 软管套筒  
FERRULE FOR SAE 100R1AT/DIN20022 1SN HOSE

代号 PART NO.	胶管 HOSE BORE		尺寸 DIMENSIONS		
	公称内径 DN	标号 DASH		L	
00110-03A	5	03		23	
00110-04A	6	04		30.5	
00110-05A	8	05		30	
00110-06A	10	06		32	
00110-08A	12	08		34	
00110-10A	16	10		37	
00110-12A	20	12		42	
00110-16A	25	16		51	

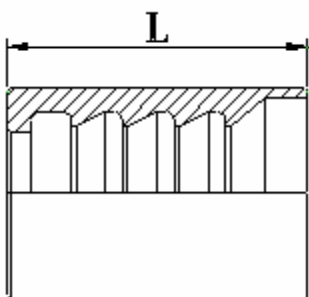

## 00200

SAE 100R2A/DIN20022 2ST 胶管套筒  
FERRULE FOR SAE 100R2AT/DIN20022 2ST HOSE

代号 PART NO.	胶管 HOSE BORE		尺寸 DIMENSIONS		
	公称内径 DN	标号 DASH		L	
00200-02	4	02		27	
00200-04	6	04		30	
00200-05	8	05		31	
00200-06	10	06		32	
00200-08	12	08		34	
00200-10	16	10		37	
00200-12	20	12		43	
00200-16	25	16		50	
00200-20	32	20		59	
00200-24	40	24		74	
00200-32	50	32		78	

## 套筒 FERRULE

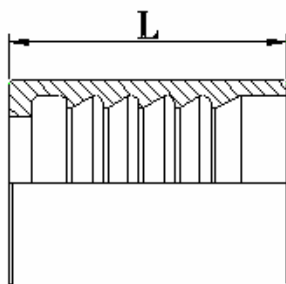

# 00210

SAE 100R2AT/EN 853 2SN 软管套筒  
FERRULE FOR SAE 100R2AT/DIN20022 2SN HOSE

代号 PART NO.	胶管 HOSE BORE		尺寸 DIMENSIONS		
	公称内径 DN	标号 DASH		L	
00210-03	5	03		24.5	
00210-04	6	04		30	
00210-05	8	05		31	
00210-06	10	06		32	
00210-08	12	08		34	
00210-10	16	10		37	
00210-12	20	12		43	
00210-16	25	16		50	
00210-20	32	20		59	
00210-24	40	24		74	
00210-32	50	32		78	

注:不推荐用于工程机械

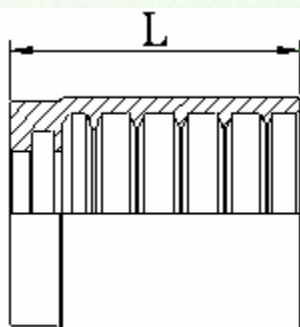

# 03310

SAE 100R2AT/EN 853 2SN 软管套筒  
FERRULE FOR SAE 100R2AT/DIN20022 2ST HOSE

代号 PART NO.	胶管 HOSE BORE		尺寸 DIMENSIONS		
	公称内径 DN	标号 DASH		L	
03310-03	5	03		23	
03310-04	6	04		30.5	
03310-05	8	05		30	
03310-06	10	06		32	
03310-08	12	08		34	
03310-10	16	10		37	
03310-12	19	12		42	
03310-16	25	16		51	
03310-20	32	20		59	
03310-24	40	24		67	
03310-32	50	32		72	

套筒 FERRULE

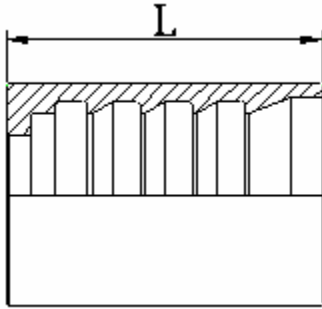

00400

4SP、4SH/12-16、R12/06-16 软管套筒  
 FERRULE FOR 4SP、4SH/10-16、R12/06-16 HOSE

代号 PART NO.	胶管 HOSE BORE		尺寸 DIMENSIONS		
	公称内径 DN	标号 DASH		L	
00400-04	6	04		37.5	
00400-06	10	06		39	
00400-08	12	08		41	
00400-10	16	10		43	
00400-12	20	12		51	
00400-16	25	16		61.5	
00400-20	32	20		67.5	
00400-24	40	24		75	
00400-32	50	32		79	

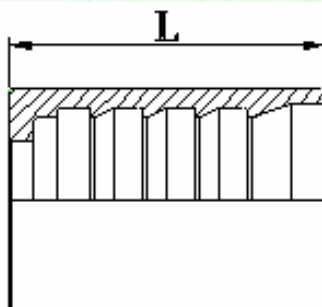

00401

4SH、R12/326 软管套筒  
 FERRULE FOR 4SP、4SH/10-16、R12/06-16 HOSE

代号 PART NO.	胶管 HOSE BORE		尺寸 DIMENSIONS		
	公称内径 DN	标号 DASH		L	
00401-20	32	20		67.5	
00401-24	40	24		75	
00401-32	50	32		79	

## 套筒 FERRULE

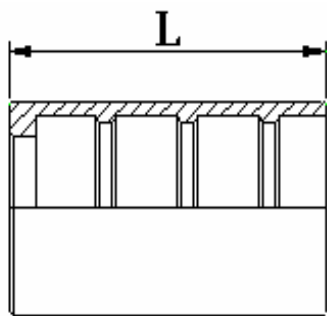

# 00018

SAE 100 R7 软管套筒

FERRULE FOR SAE 100R7 HOSE

代号 PART NO.	胶管 HOSE BORE		尺寸 DIMENSIONS		
	公称内径 DN	标号 DASH		L	
00018-03	5	03		27	
00018-04	6	04		29	
00018-05	8	05		31	
00018-06	10	06		31	
00018-08	12	08		34	
00018-10	16	10		36	
00018-12	20	12		43	
00018-16	25	16		50	

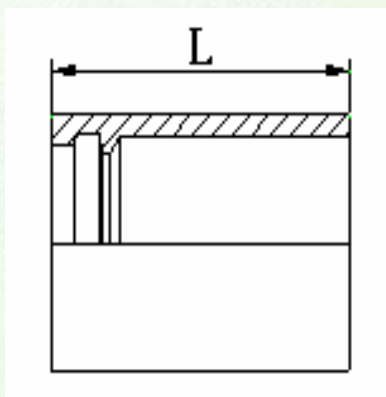

# 00TF0

铁氟龙套筒

FERRULE FOR TEFLON HOSE

代号 PART NO.	胶管 HOSE BORE		尺寸 DIMENSIONS		
	公称内径 DN	标号 DASH		L	
00TF0-03	4	03		26.5	
00TF0-04	6	04		30.7	
00TF0-05	8	05		30.6	
00TF0-06	10	06		32.1	
00TF0-08	12	08		34.3	
00TF0-10	16	10		37	
00TF0-12	20	12		42.8	
00TF0-14	22	14		42.7	
00TF0-16	25	16		50.8	



# 套筒 FERRULE

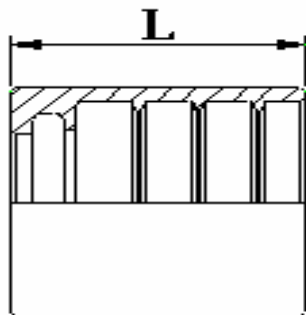

## 00500

SAE 100 R5 胶管套筒

FERRULE FOR SAE 100 R5 HOSE

代号 PART NO.	胶管 HOSE BORE			尺寸 DIMENSIONS		
	公称内径 DN	标号 DASH	SAE 标号		L	
00500-03	4	03	04		22.6	
00500-04	6	04	05		25.7	
00500-05	8	05	06		22.4	
00500-07	11	07	08		26.2	
00500-08	12	08	10		27.7	
00500-10	16	10	12		29.7	
00500-14	22	14	16		33.5	
00500-18	28	18	20		42.7	
00500-22	35	22	24		47	
00500-29	46	29	32		50.8	
00500-38	60	38	40		63.0	

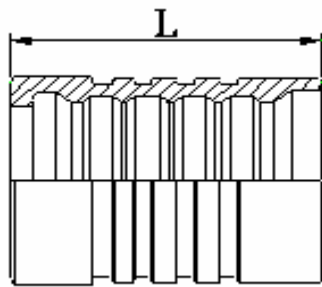

## 00621



GB/T 10544 R13/SAE 100 R13/EN856 R13

FERRULE FOR FERRULE FOR SAE 100 R5 HOSE





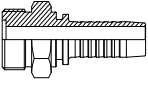
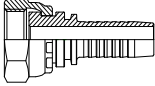
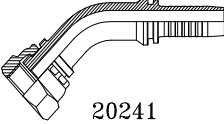
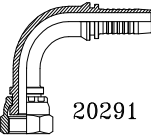
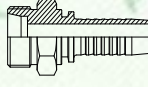
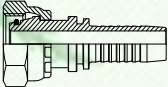
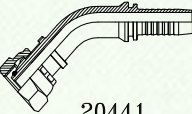
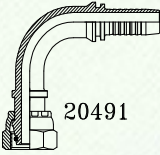
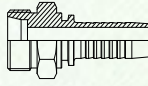
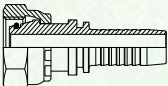
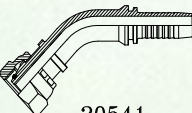
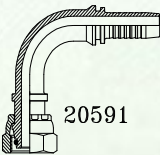

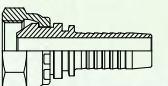
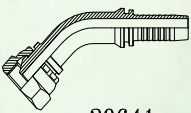
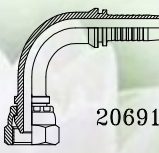
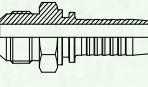
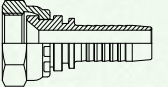
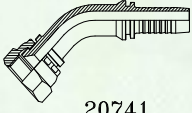
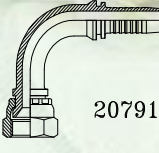
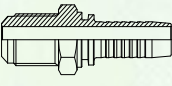
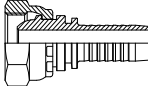
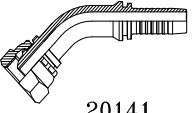
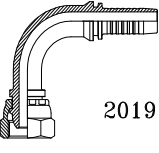

软管剥内外胶套筒

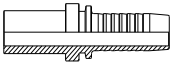
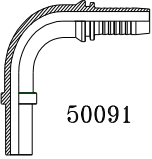
代号 PART NO.	胶管 HOSE BORE		尺寸 DIMENSIONS		
	公称内径 DN	标号 DASH		L	
00621-12	20	12		53	
00621-16	25	15		66	
00621-20	32	20		88.5	
00621-24	40	24		102	
00621-32	50	32		108	

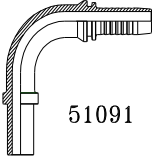
型号索引 ( INDEX )

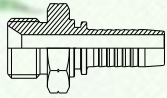
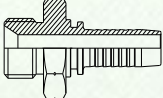
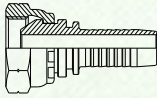
 10311	 20211	 20241	 20291
 10411	 20411	 20441	 20491
 10511	 20511	 20541	 20591
 10611	 20611	 20641	 20691
 10711	 20711	 20741	 20791
 10811L			
 20111	 20141	 20191	

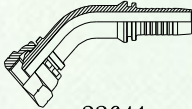
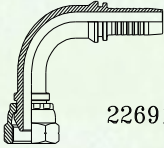
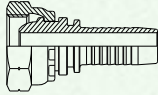
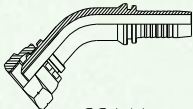
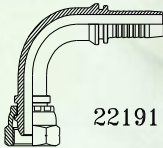
# 软管接头 HOSE FITTING

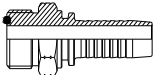
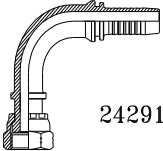
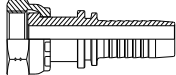
				
50011	50091	51011	51091	NL,NS
				
12211				
				
12611	12611A	22611	22611D	22611D-SM
				
22641	22691			
				
22111	22141	22191		
				
13011-SP				
				
14211	24291	24211		

# 软管接头 HOSE FITTING

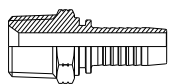

15611



16011

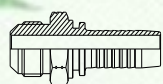

16711

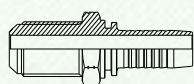

16711L

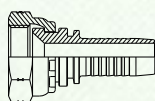

26711

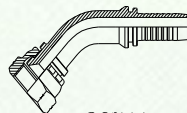

26741

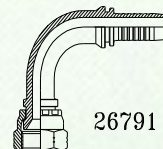

26791

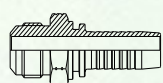

17811

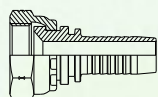

27811

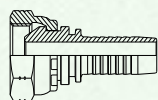

21611

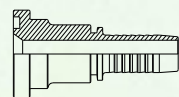

87311

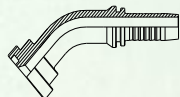

87341

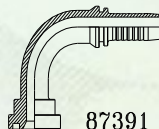

87391

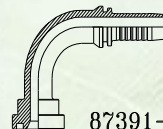

87391-H

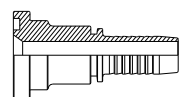

87611

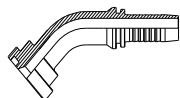



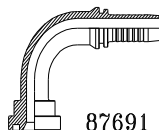

87641



87691

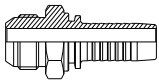

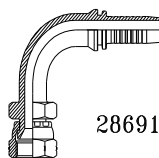
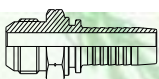
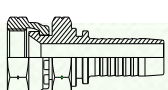
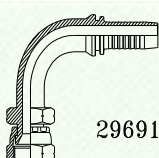
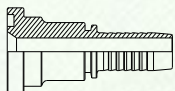
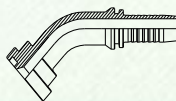
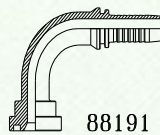
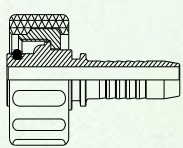
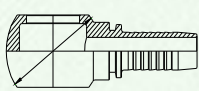
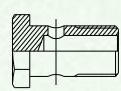
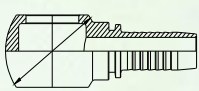
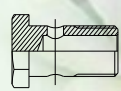
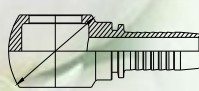
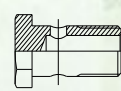
# 软管接头 HOSE FITTING

					
18611	28611	28691			
					
19611	29611	29691			
					
88111	88141	88191			
					
20011-ST					
					
70011	700M	71011	710M	72011	720B
					
90011	90012				

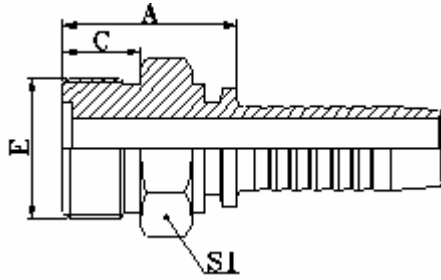

10311

公制外螺纹平面 O 形圈密封  
O-RING METRIC MALE FLAT SEAT

代 号	螺 纹 E	软 管		尺 寸		
		公称内径	标 号	A	C	S1
10311-12-04	M12X1.25	6	04	22.5	10	14
10311-14-04	M14X1.5	6	04	23.5	11	14
10311-16-04	M16X1.5	6	04	23.5	11	17
10311-16-05	M16X1.5	8	05	23.5	11	17
10311-16-06	M16X1.5	10	06	23.5	11	17
10311-18-06	M18X1.5	10	06	23.5	11	19
10311-22-05	M22X1.5	8	05	27	12	24
10311-22-06	M22X1.5	10	06	26	12	24
10311-22-08	M22X1.5	12	08	26.5	12	24
10311-27-10	M27X1.5	16	10	31.5	13	30
10311-30-12	M30X1.5	20	12	33.5	14	32
10311-36-12	M36X2	20	12	35.5	16	38
10311-36-14	M36X2	22	14	35.5	16	38
10311-39-16	M39X2	25	16	39	16	41
10311-45-20	M45X2	32	20	44.5	50	46
10311-52-24	M52X2	40	24	47.5	22	55
10311-64-32	M64X2	50	32	52.5	27	65

注: 1.上述代号用于编织软管。 2. 如需用于缠绕软管代号改为 10312-xx-xx。

NOTE : 1. FOR USE WITH BRAIDED HOSES 2. IF USE WITH SPIRAL HOSES , HOSE FITTINGS SERIES NUMBER IS 10312-XX-XX.

# 软管接头 HOSE FITTING

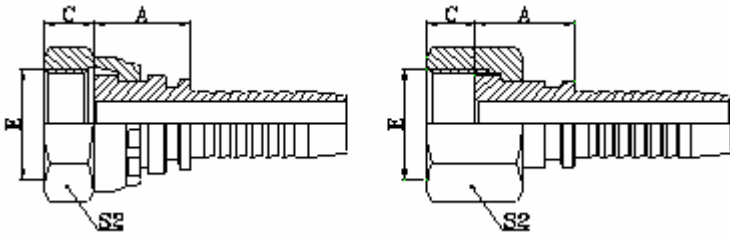

国标公制内螺纹平面  
METRIC FEMALE FLAT SEAT

20211

20211-T

代 号	螺 纹 E	软 管		尺 寸		
		公称内径	标 号	A	C	S2
20211-10-02	M10X1	4	02	14	6	14
20211-12-03	M12X1.25	5	03	14	8	17
20211-14-04	M14X1.5	6	04	16	8.5	19
20211-14-05	M14X1.5	8	05	15.5	8.5	19
20211-16-04	M16X1.5	6	04	16.5	8	22
20211-16-05	M16X1.5	8	05	17	8	22
20211-16-06	M16X1.5	10	06	16.5	8	22
20211-18-05T	M18X1.5	8	05	17.5	8	24
20211-18-06	M20X1.5	10	06	18.5	8	24
20211-20-06T	M20X1.5	10	06	16	10	24
20211-20-08	M20X1.5	12	08	18.5	10	27
20211-22-06T	M22X1.5	10	06	16	10	27
20211-22-08	M22X1.5	12	08	19.5	10	27
20211-22-10	M22X1.5	16	10	19.5	10	27
20211-24-08T	M24X1.5	12	08	16.5	11	30
20211-24-10	M24X1.5	16	10	20.5	10.5	30
20211-27-08T	M27X1.5	12	08	18.5	10	32
20211-27-10T	M27X1.5	16	10	21	10	32
20211-30-12	M30X1.5	20	12	22	11	36
20211-33-14	M33X2	22	14	21.5	13	41
20211-36-12T	M36X2	20	12	24	13	41
20211-36-14T	M36X2	22	14	24	13	41
20211-39-16T	M39X2	25	16	25	13	46
20211-42-20W	M42X2	32	20	25	15	50
20211-45-20T	M45X2	32	20	27	15	55
20211-52-24T	M52X2	40	24	27	17	60
20211-60-28T	M60X2	45	28	26	20	70
20211-64-32T	M64X2	50	32	26	23	75

注: 1.上述代号用于编织软管。 2. 如需用于缠绕软管代号改为 20212-xx-xx。

NOTE : 1. FOR USE WITH BRAIDED HOSES 2. IF USE WITH SPIRAL HOSES , HOSE FITTINGS SERIES NUMBER IS 20212-XX-XX.

# 软管接头 HOSE FITTING

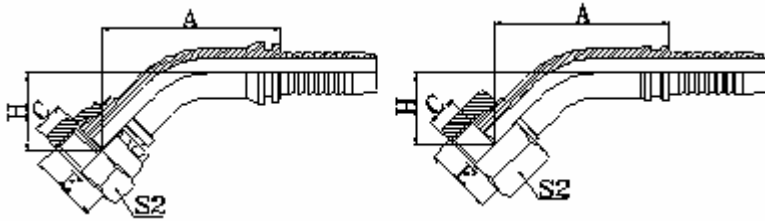

20241

20241-T

45°公制内螺纹平面  
45° METRIC FEMALE FLAT SEAT

代 号	螺纹 E	软 管		尺 寸			
		公称内径	标 号	A	C	H	S2
20241-14-04	M14X1.5	6	04	38	8.5	19	19
20241-14-05	M14X1.5	8	05	42.7	8.5	19.3	19
20241-16-05	M16X1.5	8	05	42.3	8.5	20.7	22
20241-18-06	M18X1.5	10	06	45.5	8	22	24
20241-22-08	M22X1.5	12	08	57.5	10	24.5	27
20241-27-10T	M27X1.5	16	10	58	10	24.5	32
20241-30-12T	M30X1.5	20	12	74	11	30	36
20241-36-12T	M36X2	20	12	75	13	27.5	41
20241-36-14T	M36X2	22	14	77.3	13	27	41
20241-36-16	M36X2	25	16	85.7	13	31.5	41
20241-39-16T	M39X2	25	16	82	13	30	46
20241-42-20W	M42X2	32	20	95.9	15	35.2	50
20241-45-20T	M45X2	32	20	94.5	15	35.5	55
20241-52-20T	M52X2	32	20	94.5	17	33.8	60
20241-52-24T	M52X2	40	24	105	17	38.5	60
20241-60-28T	M60X2	45	28	118.7	20	43.6	70
20241-62-32T	M64X2	50	32	127.8	23	45.6	75

注: 1.上述代号用于编织软管。 2. 如需用于缠绕软管代号改为 20242-xx-xx。

NOTE : 1. FOR USE WITH BRAIDED HOSES 2. IF USE WITH SPIRAL HOSES , HOSE FITTINGS SERIES NUMBER IS 20242-XX-XX.



# 软管接头 HOSE FITTING

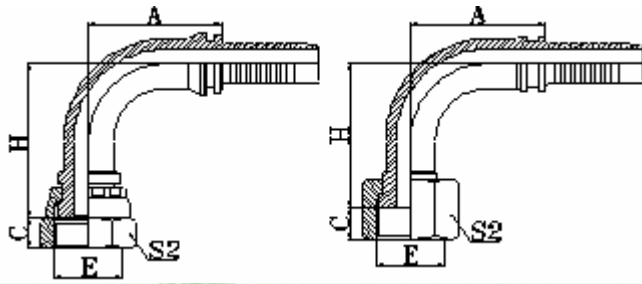

90°公制内螺纹平面

90° METRIC FEMALE FLAT SEAT

20291

20291-T

代 号	螺纹 E	软 管		尺 寸			
		公称内径	标 号	A	C	H	S2
20291-12-02	M12X1.25	4	02	26.5	8	30.5	17
20291-12-04	M12X1.25	6	04	30	8	33.5	17
20291-14-04	M14X1.5	6	04	27.5	8.5	34	19
20291-14-05	M14X1.5	8	05	33	8.5	37	19
20291-16-04	M16X1.5	6	04	30	8	35	22
20291-16-05	M16X1.5	8	05	31	8	39.5	22
20291-16-06	M16X1.5	10	06	35.3	8	40.3	22
20291-18-05T	M18X1.5	8	05	33	8	39	24
20291-18-06	M18X1.5	10	06	33	8	42	24
20291-22-08	M22X1.5	12	08	42.5	10	49.5	27
20291-22-10	M22X1.5	16	10	57.5	10	53	27
20291-24-08T	M24X1.5	12	08	41	11	45.5	30
20291-27-04T	M27X1.5	6	04	30	10	35.5	32
20291-27-08T	M27X1.5	12	08	41	10	46	32
20291-27-10T	M27X1.5	16	10	48.5	10	51.5	32
20291-30-12	M30X1.5	20	12	50.5	11	63.5	36
20291-33-14	M33X2	22	14	71.2	13	65	41
20291-36-14T	M36X2	22	14	57.5	13	64	41
20291-36-16	M36X2	25	16	66	13	76.5	41
20291-39-16T	M39X2	25	16	66	13	72.5	46
20291-42-20W	M42X2	32	20	91.5	15	80.5	50
20291-45-20T	M45X2	32	20	75	15	85	55
20291-52-20T	M52X2	32	20	91.5	17	78.5	60
20291-52-24T	M52X2	40	24	89	17	97	60
20291-60-28T	M60X2	45	28	119.9	20	106.5	70
20291-64-32T	M64X2	50	32	130.95	23	113.3	75

注: 1.上述代号用于编织软管。 2. 如需用于缠绕软管代号改为 20292-xx-xx。

NOTE : 1. FOR USE WITH BRAIDED HOSES 2. IF USE WITH SPIRAL HOSES , HOSE FITTINGS SERIES NUMBER IS 20292-XX-XX.

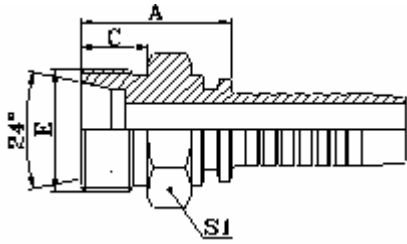

10411

公制外螺纹 24°内锥面轻系列  
 ISO 8434-1-DIN 3861  
 METRIC MALE 24°CONE SEAT L.T.

代 号	螺纹 E	软 管		管子外径	尺 寸		
		公称内径	标 号		A	C	S2
10411-12-04	M12X1.5	6	04	6	22	10	12
10411-14-04	M14X1.5	6	04	8	22	10	14
10411-14-05	M14X1.5	8	05	8	22	10	14
10411-16-04	M16X1.5	6	04	10	23.5	11	17
10411-16-05	M16X1.5	8	05	10	23.5	11	17
10411-16-06	M16X1.5	10	06	10	23.5	11	17
10411-18-05	M18X1.5	8	05	12	24	11	19
10411-18-06	M18X1.5	10	06	12	24	11	19
10411-22-06	M22X1.5	10	06	15	26.5	12	24
10411-22-08	M22X1.5	12	08	15	27	12	24
10411-26-08	M26X1.5	12	08	18	28.5	12	27
10411-26-10	M26X1.5	16	10	18	29.5	12	27
10411-27-10	M27X1.5	16	10	18	32.5	14	30
10411-30-10	M30X2	16	10	22	33.5	14	32
10411-30-12	M30X2	20	12	22	33.5	14	32
10411-36-16	M36X2	25	16	28	36	14	38
10411-45-20	M45X2	32	20	35	40	16	46
10411-52-24	M52X2	40	24	42	43	16	55

注: 1.上述代号用于编织软管。 2. 如需用于缠绕软管代号改为 10412-xx-xx。

NOTE : 1. FOR USE WITH BRAIDED HOSES 2. IF USE WITH SPIRAL HOSES , HOSE FITTINGS SERIES NUMBER IS 10412-XX-XX.

# 软管接头 HOSE FITTING

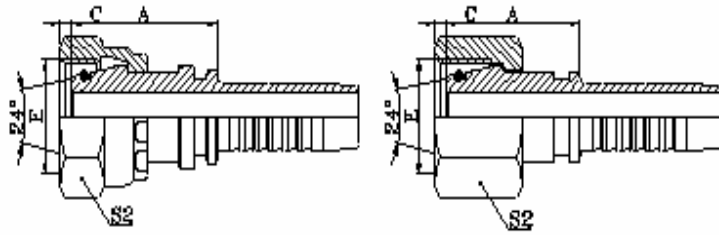

公制内螺纹 24°锥带 O 形圈轻系列  
 ISO 2151-2-DIN 3865  
 METRIC FEMALE 24° CONE O-RING L.T.

20411

20411-T

代 号	螺纹 E	软 管		管子外径	O 形圈	尺 寸		
		公称内径	标 号			A	C	S2
20411-12-04	M12X1.5	6	04	6	O04.5X1.5	25	1	17
20411-14-04	M14X1.5	6	04	8	O06.5X1.5	26.5	2	19
20411-14-06	M14X1.5	10	06	8	O06.5X1.5	27.5	2	19
20411-16-04	M16X1.5	6	04	10	O08.0X1.5	27	2	22
20411-16-05	M16X1.5	8	05	10	O08.0X1.5	27	2	22
20411-16-06	M16X1.5	10	06	10	O08.0X1.5	28	2	22
20411-18-05T	M18X1.5	8	05	12	O10.0X1.5	25.5	1.5	22
20411-18-06	M18X1.5	10	06	12	O10.0X1.5	29	2.5	24
20411-18-08	M18X1.5	12	08	12	O10.0X1.5	29.5	2.5	24
20411-22-05T	M22X1.5	8	05	15	O12.0X2	26.5	3	27
20411-22-06T	M22X1.5	10	06	15	O12.0X2	28.5	3	27
20411-22-08	M22X1.5	12	08	15	O12.0X2	32.5	2.5	27
20411-26-10	M26X1.5	16	10	18	O15.0X2	34.5	2.5	32
20411-26-12	M26X1.5	20	12	18	O15.0X2	34.5	2.5	32
20411-30-10T	M30X2	16	10	22	O20.0X2	33	3.8	36
20411-30-12	M30X2	20	12	22	O20.0X2	36.5	4	36
20411-36-12T	M36X2	20	12	28	O26.0X2	36	4.5	46
20411-36-14T	M36X2	22	14	28	O26.0X2	36.5	4.5	46
20411-45-16T	M45X2	25	16	35	O32.0X2	42	4	55
20411-45-20T	M45X2	32	20	35	O32.0X2	43	4	55
20411-52-20T	M52X2	32	20	42	O38.0X2	44.5	4	60
20411-52-24T	M52X2	40	24	42	O38.0X2	44.5	4	60

注: 1. 上述代号用于编织软管。 2. 如需用于缠绕软管代号改为 20412-xx-xx。

NOTE : 1. FOR USE WITH BRAIDED HOSES 2. IF USE WITH SPIRAL HOSES , HOSE FITTINGS SERIES NUMBER IS 20412-XX-XX.

20411C 20411C-T

公制内螺纹 24°球面 轻系列  
METRIC FEMALE MULTISEAL 24° CONE L.T.

代 号	螺 纹 E	软 管		管子外径	尺 寸		
		公称内径	标 号		A	C	S2
20411C-12-04	M12X1.5	6	04	6	19.5	3.5	17
20411C-14-04	M14X1.5	6	04	8	20.5	3.5	19
20411C-16-04	M16X1.5	6	04	10	21	3.5	22
20411C-16-05	M16X1.5	8	05	10	21	3.5	22
20411C-16-06	M16X1.5	10	06	10	21	3.5	22
20411C-18-06	M18X1.5	10	06	12	22.5	3	24
20411C-22-06T	M22X1.5	10	06	15	23.5	4.5	27
20411C-22-08	M22X1.5	12	08	15	24	4.5	27
20411C-26-10	M26X1.5	16	10	18	27	4	32
20411C-30-10T	M30X2	16	10	22	26.5	7	36
20411C-30-12	M30X2	20	12	22	27	7	36
20411C-30-14	M30X2	22	14	22	27	7	36
20411C-36-16	M36X2	25	16	28	29	6.5	41
20411C-45-20T	M45X2	32	20	35	33	7	55
20411C-52-24T	M52X2	40	24	42	34	8	60

注: 1.上述代号用于编织软管。 2. 如需用于缠绕软管代号改为 20412C-xx-xx。

NOTE : 1. FOR USE WITH BRAIDED HOSES 2. IF USE WITH SPIRAL HOSES , HOSE FITTINGS SERIES NUMBER IS 20412C-XX-XX.



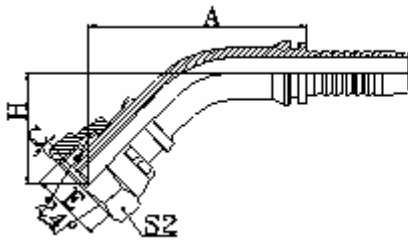

20441

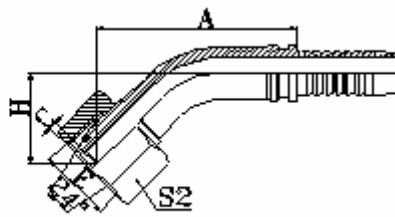

20441-T

45°公制内螺纹 24°锥带 O 形圈轻系列  
ISO 12151-2-DIN 3865  
45° METRIC FEMALE 24° CONE L.T.

代 号	螺纹 E	软 管		管子外径	O 形圈	尺 寸			
		公称内径	标 号			A	C	H	S2
20441-12-04	M14X1.5	6	04	8	O06.5X1.5	45	2	26	19
20441-16-05	M16X1.5	8	05	10	O08.0X1.5	49.5	2	27.8	22
20441-16-06	M16X1.5	10	06	10	O08.0X1.5	51.3	2	27.8	22
20441-18-05T	M18X1.5	8	05	12	O10.0X1.5	44.7	1.5	23.2	22
20441-18-06	M18X1.5	10	06	12	O10.0X1.5	53	2.5	29	24
20441-22-05T	M22X1.5	8	05	15	O12.0X2		3		27
20441-22-06T	M22X1.5	10	06	15	O12.0X2	49	3	25.3	27
20441-22-08	M22X1.5	12	08	15	O12.0X2	66.5	2.5	34	27
20441-26-08T	M26X1.5	12	08	18	O15.0X2	61	2.1	28	32
20441-26-10	M26X1.5	16	10	18	O15.0X2	70	2.5	36	32
20441-26-12	M26X1.5	20	12	18	O15.0X2		2.5		32
20441-30-10T	M30X1.5	16	10	22	O20.0X2	64	3.8	30	36
20441-30-12	M30X1.5	20	12	22	O20.0X2	84.5	4	40.5	36
20441-36-12T	M36X1.5	20	12	28	O28.0X2	79.3	4.5	35.5	46
20441-36-14T	M36X2	22	14	28	O28.0X2		4.5		46
20441-45-20T	M45X2	32	20	35	O35.0X2	101.8	4	42.4	55
20441-52-20T	M52X2	32	20	42	O42.0X2		4	46.6	60
20441-52-24T	M52X2	40	24	42	O42.0X2	113	4		60

注: 1.上述代号用于编织软管。 2. 如需用于缠绕软管代号改为 20412-xx-xx。

NOTE : 1. FOR USE WITH BRAIDED HOSES 2. IF USE WITH SPIRAL HOSES , HOSE FITTINGS SERIES NUMBER IS 20412-XX-XX.

# 软管接头 HOSE FITTING

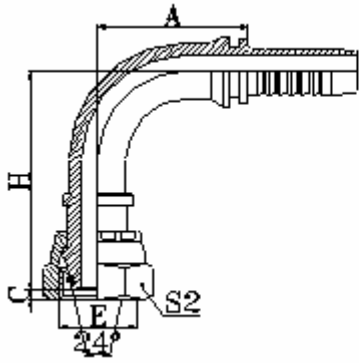

20491

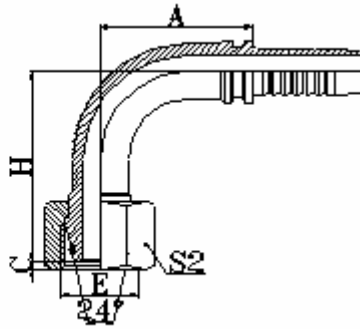

20491-T

90°公制内螺纹 24°锥带 O 形圈轻系列  
 ISO 12151-2-DIN 3865  
 90° METRIC FEMALE 24° CONE O-RING

代 号	螺纹 E	软 管		管子外径	O 形圈	尺 寸			
		公称内径	标 号			A	C	H	S2
20491-12-03	M12X1.5	5	03	6	O04.5X1.5	25.6	1	34.5	17
20491-12-04	M12X1.5	6	04	6	O04.5X1.5	27.5	1	43	17
20491-14-04	M14X1.5	6	04	8	O06.5X1.5	27.5	2	44.5	19
20491-16-04	M16X1.5	6	04	10	O08.0X1.5	27.5	2	45	22
20491-16-05	M16X1.5	8	05	10	O08.0X1.5	31	2	49.5	22
20491-16-06	M16X1.5	10	06	10	O08.0X1.5	33	2	50.5	22
20491-18-05T	M18X1.5	8	05	12	O10.0X1.5	31	1.5	43	22
20491-18-06	M18X1.5	10	06	12	O10.0X1.5	33	2.5	52.5	24
20491-22-06T	M22X1.5	10	06	15	O12.0X2.0	33	3	47	27
20491-22-08	M22X1.5	12	08	15	O12.0X2.0	42.5	2.5	62.5	27
20491-26-08T	M26X1.5	12	08	18	O15.0X2.0	42.5	2.1	54.5	32
20491-26-10	M26X1.5	16	10	18	O15.0X2.0	48.5	2.5	68	32
20491-26-12	M26X1.5	20	12	18	O15.0X2.0	50.5	2.5	76	32
20491-30-10T	M30X2	16	10	22	O20.0X2.0	48.5	3.8	59.5	36
20491-30-12	M30X2	20	12	22	O20.0X2.0	50.5	4	78	36
20491-36-12T	M36X2	20	12	28	O26.0X2.0	50.5	4.5	71	46
20491-36-14T	M36X2	22	14	28	O26.0X2.0		4.5		46
20491-45-16T	M45X2	25	16	35	O32.0X2.5	66	4	83	55
20491-45-20T	M45X2	32	20	35	O32.0X2.5	75	4	95	55
20491-52-20T	M52X2	32	20	42	O38.0X2.5	75	4	96.5	60
20491-52-24T	M52X2	40	24	42	O38.0X2.5	89	4	108.5	60

注: 1. 上述代号用于编织软管。 2. 如需用于缠绕软管代号改为 204922-xx-xx。

NOTE : 1. FOR USE WITH BRAIDED HOSES 2. IF USE WITH SPIRAL HOSES , HOSE FITTINGS SERIES NUMBER IS 20492XX-XX.

20491C

20491C-T

90° 公制内螺纹 24° 球面轻系列  
90°METRIC FEMALE 24° CONE  
MULTISEAL L.T.

代 号	螺 纹 E	软 管		管子外径	尺 寸			
		公称内径	标 号		A	C	H	S2
20491C-14-04	M14X1.5	6	04	8	30	3.5	39.5	19
20491C-16-04	M16X1.5	6	04	10	30	3.5	40	22
20491C-16-05	M16X1.5	8	05	10	33	3.5	43	22
20491C-16-06	M16X1.5	10	06	10	35.25	3.5	45.2	22
20491C-18-06	M18X1.5	10	06	12	35.25	3	47.25	24
20491C-22-08	M22X1.5	12	08	15	41	4.5	53	27
20491C-26-10	M26X1.5	16	10	18	56.5	4	60	32
20491C-30-12	M30X2	20	12	22	65.5	7	38.5	36
20491C-36-12T	M36X2	20	12	28	65.5	6.5	67.5	41

注: 1.上述代号用于编织软管。 2. 如需用于缠绕软管代号改为 20491C-xx-xx。

NOTE : 1. FOR USE WITH BRAIDED HOSES 2. IF USE WITH SPIRAL HOSES , HOSE FITTINGS SERIES NUMBER IS 20492C-XX-XX.

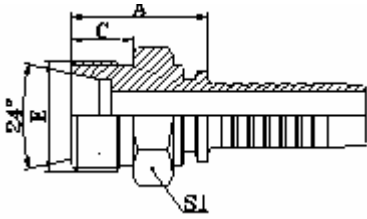

**10511**  
公制外螺纹 24° 内锥面重系列  
ISO-84341—DIN 3861  
METRIC MALE 24° CONE SEAT H.T.

代 号	螺 纹 E	软 管		管子外径	尺 寸		
		公称内径	标 号		A	C	S1
10511-14-04	M14X1.5	6	04	6	24	12	14
10511-16-04	M16X1.5	6	04	8	24.5	12	17
10511-18-04	M18X1.5	6	04	10	25	12	19
10511-20-05	M20X1.5	8	05	12	26	12	22
10511-20-06	M20X1.5	10	06	12	26	12	22
10511-22-05	M22X1.5	8	05	14	28.5	14	24
10511-22-06	M22X1.5	10	06	14	28.5	14	24
10511-22-08	M22X1.5	12	08	14	29	14	24
10511-24-08	M24X1.5	12	08	16	30	14	27
10511-30-10	M30X2	16	10	20	35.5	16	32
10511-30-12	M30X2	20	12	20	35.5	16	32
10511-36-12	M36X2	20	12	25	38.5	18	38
10511-36-16	M36X2	25	16	25	40	18	38
10511-42-16	M42X2	25	16	30	43	20	46
10511-42-20	M42X2	32	20	30	44	20	46
10511-52-20	M52X2	32	20	38	48	22	55

注: 1.上述代号用于编织软管。 2. 如需用于缠绕软管代号改为 20512-xx-xx。

NOTE : 1. FOR USE WITH BRAIDED HOSES 2. IF USE WITH SPIRAL HOSES , HOSE FITTINGS SERIES NUMBER IS 10512-XX-XX.



# 软管接头 HOSE FITTING

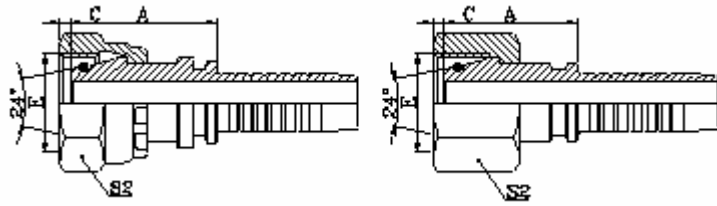

公制内螺纹  
 锥带 O 形圈重系列  
 ISO 12151-2—DIN 386  
 METRIC FEMALE 24° CONE  
 O-RING H.T.

20511

20511-T

代 号	螺纹 E	软 管		管子外径	O 形圈	尺 寸		
		公称内径	标 号			A	C	S1
20511-14-04	M16X1.5	6	04	6	O04.5X1.5	27.4	1.5	19
20511-16-04	M16X1.5	6	04	8	O06.5X1.5	27.5	1.5	22
20511-16-05	M16X1.5	8	05	8	O06.5X1.5	27.5	1.5	22
20511-18-04T	M18X1.5	6	04	10	O08.0X1.5	26	1.5	22
20511-18-06	M18X1.5	10	06	10	O08.0X1.5	29.5	2	24
20511-20-06T	M20X1.5	10	06	12	O10.0X1.5	27.5	2.5	24
20511-20-08	M20X1.5	12	08	12	O10.0X1.5	31.5	2.5	27
20511-22-06T	M22X1.5	10	06	14	O11.0X2.0	28.5	3	27
20511-22-08	M22X1.5	12	08	14	O11.0X2.0	32.5	2.5	27
20511-24-06T	M24X1.5	10	06	16	O13.0X2.0	27	3	30
20511-24-08T	M24X1.5	12	08	16	O13.0X2.0	30	3	30
20511-30-10T	M30X2	16	10	20	O16.3X2.4	33.5	2.5	36
20511-30-12	M30X2	20	12	20	O16.3X2.4	37	3	36
20511-36-12T	M36X2	20	12	25	O20.3X2.4	37	3.2	46
20511-36-14T	M36X2	22	14	25	O20.3X2.4	37	3.2	46
20511-42-12T	M42X2	20	12	30	O25.3X2.4	37.5	3.9	50
20511-42-16T	M42X2	25	16	30	O25.3X2.4	41	3.9	50
20511-52-20T	M52X2	32	20	38	O33.3X2.4	44	4.5	60
20511-52-24T	M52X2	40	24	38	O33.3X2.4	44	4.5	60

注: 1. 上述代号用于编织软管。 2. 如需用于缠绕软管代号改为 20512-xx-xx。

NOTE : 1. FOR USE WITH BRAIDED HOSES 2. IF USE WITH SPIRAL HOSES , HOSE FITTINGS SERIES NUMBER IS20512-XX-XX.

20511C 20511C-T

公制内螺纹 24° 球面重系列  
METRIC FEMALE 24° MULTISEAL H.T.

代 号	螺纹 E	软 管		管子外径	尺 寸			
		公称内径	标 号		A	C	S2	
20511C-18-04T	M18X1.5	6	04	10	21	3	22	
20511C-20-05T	M20X1.5	8	05	12	21.5	4.5	24	
20511C-20-06T	M20X1.5	10	06	12	21.5	4.5	24	
20511C-22-06T	M22X1.5	10	06	14	21.5	4.5	27	
20511C-24-08T	M24X1.5	12	08	16	23	5	30	
20511C-30-10T	M30X2	16	10	20	26.5	7	36	
20511C-36-12T	M36X2	20	12	25	27	6.5	41	
20511C-42-16T	M42X2	25	16	30	29.5	9	50	
20511C-52-20T	M52X2	32	20	38	34	8	60	

注: 1.上述代号用于编织软管。 2. 如需用于缠绕软管代号改为 20512C-xx-xx。

NOTE : 1. FOR USE WITH BRAIDED HOSES 2. IF USE WITH SPIRAL HOSES , HOSE FITTINGS SERIES NUMBER IS20512C-XX-XX.

# 软管接头 HOSE FITTING

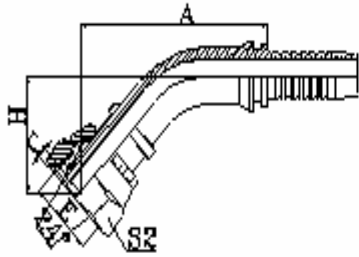

20541

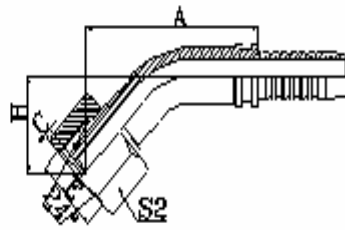

20541-T

45° 公制内螺纹  
 24° 锥带 O 形圈重系列  
 ISO 12151-2-DIN  
 45° METRIC FEMALE  
 24° CONE O-RING H.T.

代 号	螺纹 E	软 管		管子外径	O 形圈	尺 寸			
		公称内径	标 号			A	C	H	S2
20541-14-04	M16X1.5	6	04	6	O04.5X1.5	46	1.5	27	19
20541-16-04	M16X1.5	6	04	8	O06.5X1.5	46	1.5	27	22
20541-16-05	M16X1.5	8	05	8	O06.5X1.5	49.5	1.5	28.1	22
20541-18-04T	M18X1.5	6	04	10	O08.0X1.5	41.5	1.5	22.5	22
20541-18-06	M18X1.5	10	06	10	O08.0X1.5	53	2	29.5	24
20541-20-06T	M20X1.5	10	06	12	O10.0X1.5	48.5	2.5	25	24
20541-20-08	M20X1.5	12	08	12	O10.0X1.5	65.9	2.5	33	27
20541-22-06T	M22X1.5	10	06	14	O11.0X2.0	48.9	3	25.3	27
20541-22-08	M22X1.5	12	08	14	O11.0X2.0	66.5	2.5	34	27
20541-24-08T	M24X1.5	12	08	16	O13.0X2.0	61.3	3	28.5	30
20541-30-10T	M30X2	16	10	20	O16.3X2.4	64.5	2.5	30.8	36
20541-30-12	M30X2	20	12	20	O16.3X2.4	84.5	3	41	36
20541-36-12T	M36X2	20	12	25	O20.3X2.4	80	3.2	36	46
20541-36-14T	M36X2	22	14	25	O20.3X2.4		3.2		46
20541-42-16T	M42X2	25	16	30	O25.3X2.4	89.4	3.9	37.5	50
20541-52-20T	M52X2	32	20	38	O33.3X2.4	102	4.5	42.8	60
20541-52-24T	M52X2	40	24	38	O33.3X2.4		4.5		60

注: 1.上述代号用于编织软管。 2. 如需用于缠绕软管代号改为 20542-xx-xx。

NOTE : 1. FOR USE WITH BRAIDED HOSES 2. IF USE WITH SPIRAL HOSES , HOSE FITTINGS SERIES NUMBER IS20542-XX-XX.

20541C

20541C-T

45° 公制内螺纹 24° 球面系列 DIN3868  
45° METRIC FEMALE 24° MULTISEAL H.T.

代 号	螺 纹 E	软 管		管子外径	尺 寸			
		公称内径	标 号		A	C	H	S2
20541C-16-04	M16X1.5	6	04	8	44.8	3	22.7	19
20541C-18-04T	M18X1.5	6	04	10	43.7	3	21.6	22
20541C-20-06T	M20X1.5	10	06	12	48.9	4.5	24.6	24
20541C-24-08T	M24X1.5	12	08	16	61.4	2.5	26.5	30

注: 1.上述代号用于编织软管。 2. 如需用于缠绕软管代号改为 20542Cxx-xx。

NOTE : 1. FOR USE WITH BRAIDED HOSES 2. IF USE WITH SPIRAL HOSES , HOSE FITTINGS SERIES NUMBER IS20542C-XX-XX.



# 软管接头 HOSE FITTING

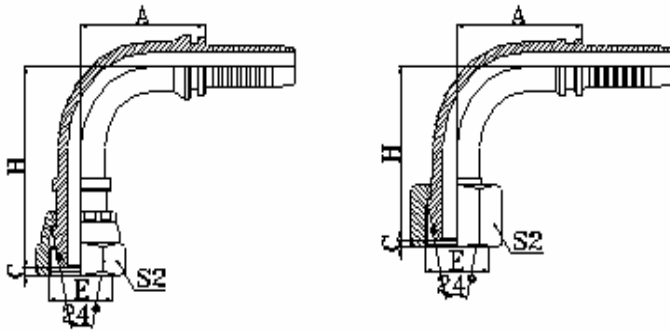

20591

20591-T

90° 公制内螺纹  
 24° 锥带 O 形圈重系列  
 ISO 12151-2-DIN 3865  
 90°METRIC FEMALE 24°CONE  
 O-RING H.T.

代 号	螺纹 E	软 管		管子外径	O 形圈	尺 寸			
		公称内径	标 号			A	C	H	S 2
20591-14-04	M16X1.5	6	04	6	O04.5X1.5	27.5	1.5	45.4	19
20591-16-04	M16X1.5	6	04	8	O06.5X1.5	27.5	1.5	45.5	22
20591-16-05	M16X1.5	8	05	8	O06.5X1.5	31	1.5	50	22
20591-18-05T	M18X1.5	8	05	10	O08.0X1.5	31	1.5	43.5	22
20591-18-06	M18X1.5	10	06	10	O08.0X1.5	33	2	53	24
20591-20-06T	M20X1.5	10	06	12	O10.0X1.5	33	2.5	46.5	24
20591-20-08	M20X1.5	12	08	12	O10.0X1.5	42.5	2.5	61.5	27
20591-22-06T	M22X1.5	10	06	14	O11.0X2.0	33	3	47	27
20591-22-08	M22X1.5	12	08	14	O11.0X2.0	42.5	2.5	62.5	27
20591-24-08T	M24X1.5	12	08	16	O13.0X2.0	42.5	3	55	30
20591-24-10	M24X1.5	16	10	16	O13.0X2.0	48.5	2.5	68	30
20591-30-10T	M30X2	16	10	20	O16.3X2.4	48.5	2.5	60.5	36
20591-30-12	M30X2	20	12	20	O16.3X2.4	50.5	3	78.5	36
20591-36-12T	M36X2	20	12	25	O20.3X2.4	50.5	3.2	72	46
20591-36-14T	M36X2	22	14	25	O20.3X2.4	57.5	3.2	74	46
20591-42-16T	M42X2	25	16	30	O25.3X2.4	66	3.9	83	50
20591-52-20T	M52X2	32	20	38	O33.3X2.4	75	4.5	95.5	60
20591-52-24T	M52X2	40	24	38	O33.3X2.4	93	4.5	107.5	60

注: 1.上述代号用于编织软管。 2. 如需用于缠绕软管代号改为 20592-xx-xx。

NOTE : 1. FOR USE WITH BRAIDED HOSES 2. IF USE WITH SPIRAL HOSES , HOSE FITTINGS SERIES NUMBER IS 20592-XX-XX.

20591C 20591C-T

90° 公制内螺纹 24° 球面重系列  
90° METRIC FEMALE 24° MULTISEAL H.T.

代 号	螺 纹 E	软 管		管子外径	尺 寸			
		公称内径	标 号		A	C	H	S2
20591C-16-04	M16X1.5	6	04	8	30	3	40	22
20591C-18-04T	M18X1.5	6	04	10	30	3	38.5	22
20591C-20-05T	M20X1.5	8	05	12	33	4.5	42	24
20591C-20-06T	M20X1.5	10	06	12	35.3	4.5	45.7	24
20591C-22-06T	M22X1.5	10	06	14	35.3	4.5	44.7	27
20591C-24-08T	M24X1.5	12	08	16	41	5	52	30
20591C-30-10T	M30X2	16	10	20	56.5	7	56.5	36
20591C-36-12T	M36X2	20	12	25	65.5	6.5	66.5	41
20591C-42-16T	M42X2	25	16	30	78	9	73.5	50
20591C-52-20T	M52X2	32	20	38	93	8	87.5	60

注: 1.上述代号用于编织软管。 2. 如需用于缠绕软管代号改为 20592C-xx-xx。

NOTE : 1. FOR USE WITH BRAIDED HOSES 2. IF USE WITH SPIRAL HOSES , HOSE FITTINGS SERIES NUMBER IS20592C-XX-XX.

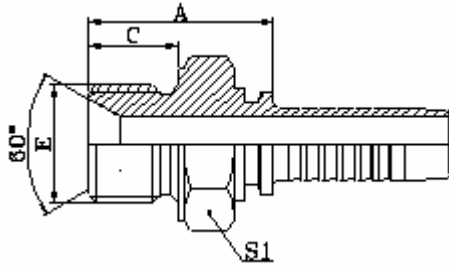

### 10611

公制外螺纹 60° 内锥面或六角编面  
用组合垫密封的双用接头

METRIC MALE DOUBLE USE FOR 60°

代 号	螺纹 E	软 管		尺 寸			
		公称内径	标 号	A	C	S1	
10611-14-04	M14X1.5	6	04	23.5	11	19	
10611-14-06	M14X1.5	10	06	25	11	19	
10611-16-04	M16X1.5	6	04	27.5	12	22	
10611-16-05	M16X1.5	8	05	27.5	12	22	
10611-18-06	M18X1.5	10	06	29.5	12	24	
10611-22-06	M22X1.5	10	06	30.5	14	27	
10611-22-08	M22X1.5	12	08	31	14	27	
10611-24-10	M24X1.5	16	10	35	14	30	
10611-26-10	M26X1.5	16	10	35	16	32	
10611-27-10D	M27X1.5	16	10	35	16	32	
10611-27-10	M27X1.5	16	10	37	18	32	
10611-30-12D	M30X2	20	12	38	18	36	
10611-30-12	M30X2	20	12	38	18	36	
10611-33-16	M33X2	25	16	43	20	46	
10611-42-20	M42X2	32	20	46	20	50	
10611-45-20	M45X2	32	20	46	20	55	
10611-48-24	M48X2	40	24	46	20	55	
10611-52-24	M52X2	40	24	46	20	60	

注: 1. 上述代号用于编织软管。 2. 如需用于缠绕软管代号改为 10612xx-xx。

NOTE : 1. FOR USE WITH BRAIDED HOSES 2. IF USE WITH SPIRAL HOSES , HOSE FITTINGS SERIES NUMBER IS 10612-XX-XX.

# 软管接头 HOSE FITTING

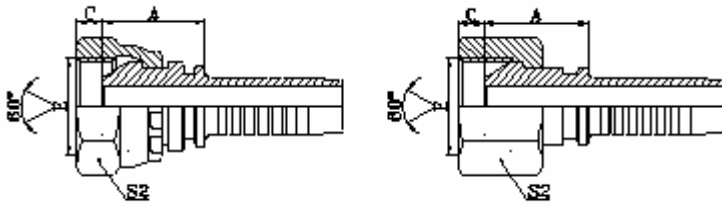

公制外内螺纹 60°  
METRIC FEMALE 60°CONE

20611

20611-T

代 号	螺纹 E	软 管		尺 寸			
		公称内径	标 号	A	C	S2	
20611-14-04	M14X1.5	6	04	19	5.5	19	
20611-16-05	M16X1.5	8	05	19.5	5.5	22	
20611-16-06	M16X1.5	10	06	19	5.5	22	
20611-18-06	M18X1.5	10	06	21	5.5	24	
20611-20-08	M20X1.5	12	08	22	6.5	27	
20611-22-08	M22X1.5	12	08	23.5	6	27	
20611-24-10	M24X1.5	16	10	24.5	6.5	30	
20611-26-10	M26X1.5	16	10	25	6	32	
20611-27-10DT	M27X1.5	16	10	25.5	6	32	
20611-27-10T	M27X1.5	16	10	25.5	6	32	
20611-30-10D	M30X2	16	10	26.5	6	36	
20611-30-12D	M30X2	20	12	26.5	6	36	
20611-30-12	M30X2	20	12	27	6	36	
20611-36-16	M36X2	25	16	30	6.5	41	
20611-39-16T	M39X2	25	16	30	6.5	46	
20611-45-20T	M45X2	32	20	31	8.5	55	
20611-52-24T	M52X2	40	24	32	10	60	

注: 1. 上述代号用于编织软管。 2. 如需用于缠绕软管代号改为 20612-xx-xx。

NOTE : 1. FOR USE WITH BRAIDED HOSES 2. IF USE WITH SPIRAL HOSES , HOSE FITTINGS SERIES NUMBER IS20612-XX-XX.



# 软管接头 HOSE FITTING

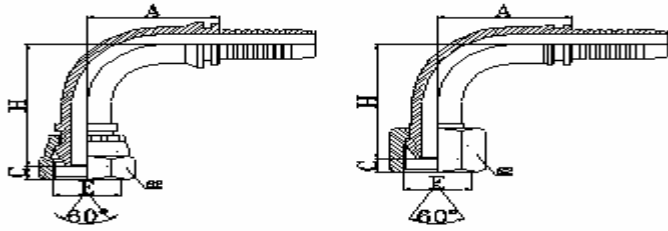

90° 公制外内螺纹 60° 外锥面  
90°METRIC FEMALE 60°CONE

20691

20691-T

代 号	螺 纹 E	软 管		尺 寸			
		公称内径	标 号	A	C	H	S2
20611-14-04	M14X1.5	6	04	27.5	5.5	37	19
20611-16-05	M16X1.5	8	05	31	5.5	42	22
20611-18-06	M18X1.5	10	06	33	5.5	44.5	24
20611-22-08	M22X1.5	12	08	42.5	6	53.5	27
20611-27-10DT	M27X1.5	16	10	56	6	55	32
20611-30-12D	M30X2	20	12	66.2	6	68.5	36
20611-36-16	M36X2	25	16	78	6.5	76.5	41
20611-36-14T	M36X2	22	14	71.2	6.5	67.5	41
20611-39-16T	M39X2	25	16	76.7	6.5	74	46
20611-45-20T	M45X2	32	20	91.5	8.5	85	55
20611-52-24T	M52X2	40	24	109.4	10	99	60

注: 1.上述代号用于编织软管。 2. 如需用于缠绕软管代号改为 20692-xx-xx。

NOTE : 1. FOR USE WITH BRAIDED HOSES 2. IF USE WITH SPIRAL HOSES , HOSE FITTINGS SERIES NUMBER IS20692-XX-XX.

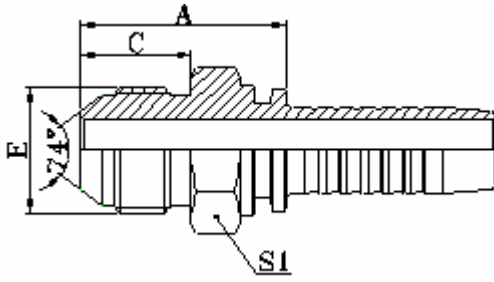

10711

国际公制外螺纹 74° 外锥面

METRIC MALE 74° CONE

代 号	螺纹 E	软 管		尺 寸			
		公称内径	标 号	A	C	S1	
10711-10-02	M10X1	4	02	23	12.5	14	
10711-10-03	M10X1	5	03	23	12.5	14	
10711-12-03	M12X1.5	5	03	26.5	15.7	14	
10711-12-03C	M12X1.25	5	03	24.5	14	14	
10711-14-04	M14X1.5	6	04	30.5	18	17	
10711-14-06	M14X1.5	10	06	30.5	18	17	
10711-16-05	M16X1.5	8	05	31.5	19	17	
10711-16-06	M16X1.5	10	06	31.5	19	17	
10711-18-06	M18X1.5	10	06	32	19	19	
10711-22-08	M22X1.5	12	08	34.5	19.5	24	
10711-24-08	M24X1.5	12	08	36.5	20	27	
10711-27-10	M27X1.5	16	10	39	20.5	30	
10711-30-12	M30X2	20	12	42.5	23	32	
10711-30-12E	M30X2	20	12	45.5	26	32	
10711-33-12	M33X2	20	12	46.5	26	36	
10711-36-14	M36X2	22	14	47	26	38	
10711-39-16	M39X2	25	16	50	27.5	41	
10711-42-20	M42X2	32	20	52.5	28.5	46	
10711-45-20	M45X2	32	20	52.5	28.5	46	

注: 1.上述代号用于编织软管。 2. 如需用于缠绕软管代号改为 10712-xx-xx。

NOTE : 1. FOR USE WITH BRAIDED HOSES 2. IF USE WITH SPIRAL HOSES , HOSE FITTINGS SERIES NUMBER IS10712-XX-XX.

# 软管接头 HOSE FITTING

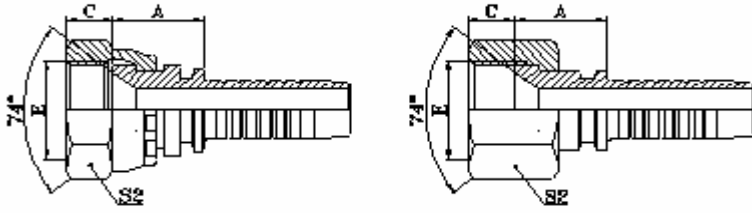

国际公制内螺纹 74° 内锥  
METRIC FEMALE 74° CONE SEAT

## 20711

## 20711-T

代 号	螺纹 E	软 管		尺 寸			
		公称内径	标 号	A	C	S2	
20711-10-02	M10X1	4	02	14	7.5	14	
20711-12-03C	M12X1.25	5	03	14	9	17	
20711-12-03	M12X1.5	5	03	14	10	17	
20711-12-04	M12X1.5	6	04	15	10	17	
20711-14-04	M14X1.5	6	04	16	8.5	19	
20711-14-05	M14X1.5	8	05	15.5	8.5	19	
20711-14-06	M14X1.5	10	06	15.5	8.5	19	
20711-16-04	M16X1.5	6	04	16.5	8	22	
20711-16-05	M16X1.5	8	05	17	8	22	
20711-16-06	M16X1.5	10	06	16	8	22	
20711-18-05T	M18X1.5	8	05	16	8	22	
20711-18-06	M18X1.5	10	06	18.5	10	24	
20711-20-06T	M20X1.5	10	06	16	10	24	
20711-20-08	M20X1.5	12	08	18.5	10	27	
20711-22-06T	M22X1.5	10	06	16	10	27	
20711-22-08	M22X1.5	12	08	19.5	10	27	
20711-22-10	M22X1.5	16	10	19	10	27	
20711-24-08T	M24X1.5	12	08	16.5	11	30	
20711-27-08T	M27X1.5	12	08	18.5	11	32	
20711-27-10T	M27X1.5	16	10	21	11	32	
20711-27-12	M27X1.5	20	12	21.5	11	32	
20711-30-10T	M30X1.5	16	10	18	11	36	
20711-30-12	M30X1.5	20	12	22	11	36	
20711-33-10T	M33X2	16	10	19.5	13	41	
20711-33-12T	M33X2	20	12	20	13	41	
20711-33-14	M33X2	22	14	21.5	13	41	
20711-36-12T	M36X2	20	12	20	14	41	
20711-36-14T	M36X2	22	14	24	14	41	
20711-36-16	M36X2	25	16	23	14	41	
20711-39-16T	M39X2	25	16	25	14	46	
20711-42-16T	M42X2	25	16	23.5	15	50	
20711-42-20W	M42X2	32	20	24.5	15	50	
20711-45-20T	M45X2	32	20	27	15	55	
20711-52-24T	M52X2	40	24	27	17	60	

注: 1. 上述代号用于编织软管。 2. 如需用于缠绕软管代号改为 20712-xx-xx。

NOTE : 1. FOR USE WITH BRAIDED HOSES 2. IF USE WITH SPIRAL HOSES , HOSE FITTINGS SERIES NUMBER IS 20712-XX-XX.

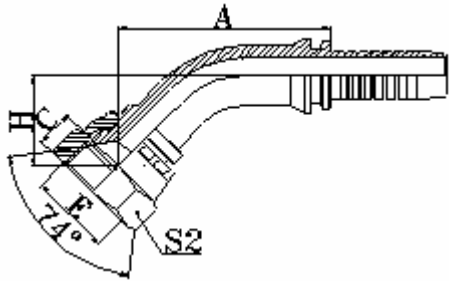

## 20741

45° 国际公制内螺纹 74° 内锥面  
45°METRIC FEMALE 74°CONE SEAT

代 号	螺纹 E	软 管		尺 寸			
		公称内径	标 号	A	C	H	S2
20741-14-04	M14X1.5	6	04	38	8.5	19	19
20741-16-05	M16X1.5	8	05	42.3	8	20.7	22
20741-18-06	M18X1.5	10	06	45.5	10	22	24
20741-22-08	M22X1.5	12	08	57.5	10	24.5	27
20741-27-10	M27X1.5	16	10	60	11	26.5	32
20741-30-12	M30X1.5	20	12	74	11	30	36
20741-33-12	M33X2	20	12	77.4	13	30	41
20741-33-16	M33X2	25	16	85	13	30.8	41
20741-36-14	M36X2	22	14	79.8	14	29.6	4
20741-36-16	M36X2	25	16	85.7	14	31.5	41
20741-39-16	M39X2	25	16	85	14	33	46
20741-45-20W	M45X2	32	20	97	15	36.2	55
20741-52-24W	M52X2	40	24	115.3	17	40.9	60

注: 1.上述代号用于编织软管。 2. 如需用于缠绕软管代号改为 20742-xx-xx。

NOTE : 1. FOR USE WITH BRAIDED HOSES 2. IF USE WITH SPIRAL HOSES , HOSE FITTINGS SERIES NUMBER IS 20742-XX-XX.

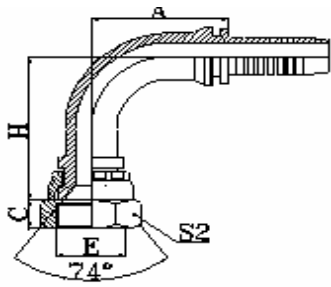

20791

90° 国际公制内螺纹 74° 内锥面  
90°METRIC FEMALE 74°CONE SEAT

代 号	螺纹 E	软 管		尺 寸			
		公称内径	标 号	A	C	H	S2
20791-12-04C	M12X1.25	6	04	30	9	33.5	17
20791-12-04	M12X1.5	6	04	30	10	33.5	17
20791-14-04	M14X1.5	6	04	27.5	8.5	34	19
20791-16-04	M16X1.5	6	04	30	8	35	22
20791-16-05	M16X1.5	8	05	31	8	39.5	22
20791-18-06	M18X1.5	10	06	33	10	42	24
20791-22-08	M22X1.5	12	08	42.5	10	49.5	27
20791-22-10	M22X1.5	16	10	56	10	52.5	27
20791-27-10	M27X1.5	16	10	48.5	11	54.5	32
20791-30-12	M30X1.5	20	12	50.5	11	63.5	36
20791-33-12	M33X2	20	12	65.5	13	63.5	41
20791-33-16	M33X2	25	16	66	13	75.5	41
20791-36-12	M36X2	20	12	65.5	124	63.5	41
20791-36-14	M36X2	22	14	71.2	14	64.5	41
20791-39-16	M39X2	25	16	66	14	76.5	46
20791-45-20W	M45X2	32	20	91.5	15	83	55
20791-52-20W	M52X2	32	20	93	17	84.5	60
20791-52-24W	M52X1.5	40	24	110.7	17	96.5	60

注: 1.上述代号用于编织软管。 2. 如需用于缠绕软管代号改为 20792-xx-xx。

NOTE : 1. FOR USE WITH BRAIDED HOSES 2. IF USE WITH SPIRAL HOSES , HOSE FITTINGS SERIES NUMBER IS 20792-XX-XX.



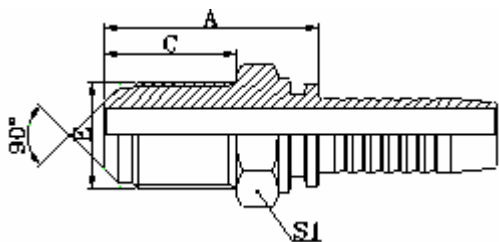

10811L

公制外螺纹 90° 外锥面

METRIC MALE 90°CONE

代 号	螺 纹 E	软 管		尺 寸			
		公称内径	标 号	A	C	H	S2
10811L-12-04	M12X1.5	6	04	46	34	17	17
10811L-12-04A	M12X1	6	04	44.5	32.5	17	17
10811L-14-04	M14X1.5	6	04	46	34	17	19
10811L-14-06	M14X1.5	10	06	46.5	34	17	19
10811L-16-04	M16X1.5	6	04	46.5	34	19	22
10811L-16-06	M16X1.5	10	06	46.5	34	22	22
10811L-20-06	M20X1.5	10	06	57	40	27	27
10811L-20-08	M20X1.5	12	08	57.5	40	27	27
10811L-22-08	M22X1.5	12	08	62.5	45	27	27



# 软管接头 HOSE FITTING

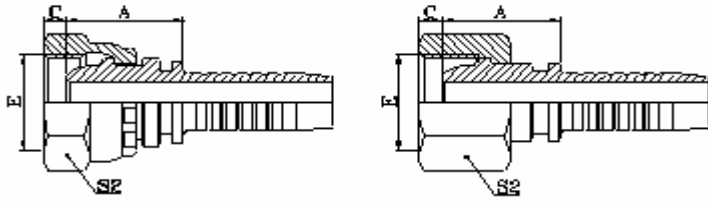

公制内螺纹球面

METRIC FEMALE MULTISEAL

20111

20111-T

代 号	螺纹 E	软 管		尺 寸			
		公称内径	标 号	A	C	S2	
20111-10-03	M10X1	5	03	18	2.5	14	
20111-10-04	M10X1	6	04	18	2.5	14	
20111-12-04	M12X1.5	6	04	18.5	4	17	
20111-12-05	M12X1.5	8	05	18.5	4	17	
20111-14-04	M14X1.5	6	04	20	4.5	19	
20111-14-05	M14X1.5	8	05	19.5	4.5	19	
20111-16-04	M16X1.5	6	04	20.5	4.5	22	
20111-16-05	M16X1.5	8	05	20.5	4.5	22	
20111-16-06	M16X1.5	10	06	20	4.5	22	
20111-18-05T	M18X1.5	8	05	21.5	4	24	
20111-18-06	M18X1.5	10	06	22.5	4	24	
20111-18-08	M18X1.5	12	08	22	4	24	
20111-20-06T	M20X1.5	10	06	23.5	5.5	24	
20111-20-08	M20X1.5	12	08	23	5.5	27	
20111-22-06T	M22X1.5	10	06	23	5	27	
20111-22-08	M22X1.5	12	08	24.5	5	27	
20111-22-10	M22X1.5	16	10	24.5	5	27	
20111-24-08T	M24X1.5	12	08	22	5.5	30	
20111-24-10	M24X1.5	16	10	26	5	30	
20111-27-08DT	M27X1.5	12	08	23	5.5	32	
20111-27-10DT	M27X1.5	16	10	26	5.5	32	
20111-27-12D	M27X1.5	20	12	26	5.5	32	
20111-27-10T	M27X2	16	10	26	7	32	
20111-30-12D	M30X1.5	20	12	26.5	6	36	
20111-30-12	M30X2	20	12	26	7	36	
20111-36-12T	M36X2	20	12	26	7	41	
20111-36-14T	M36X2	22	14	26	7	41	
20111-39-14T	M39X2	22	14	28.5	7	46	
20111-39-16T	M39X2	25	16	34	7	46	
20111-42-16T	M42X2	25	16	30	8.5	50	
20111-45-20T	M45X2	32	20	31.5	8.5	55	
20111-52-20T	M52X2	32	20	33	9	60	
20111-52-24T	M52X2	40	24	33	9	60	
20111-64-32T	M64X2	50	32	35	14	75	

注: 1. 上述代号用于编织软管。 2. 如需用于缠绕软管代号改为 20112-xx-xx。

NOTE : 1. FOR USE WITH BRAIDED HOSES 2. IF USE WITH SPIRAL HOSES , HOSE FITTINGS SERIES NUMBER IS 20112-XX-XX.

# 软管接头 HOSE FITTING

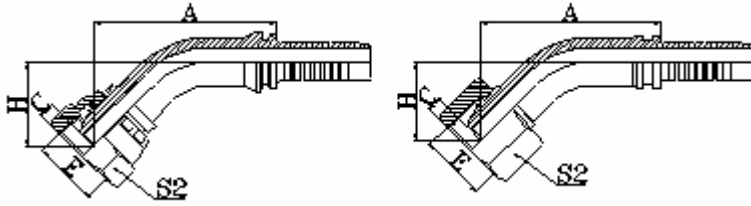

45° 公制内螺纹球面  
45° METRIC FEMALE MULTISEAL

20141

20141-T

代 号	螺纹 E	软 管		尺 寸			
		公称内径	标 号	A	C	H	S2
20141-10-03	M10X1	5	03	41.1	2.5	20.7	14
20141-10-04	M10X1	6	04	43.2	2.5	21.5	14
20141-12-03	M12X1.5	5	03	40.9	4	21.2	17
20141-12-04	M12X1.5	9	04	43	4	22	17
20141-14-04	M14X1.5	6	04	43.4	4.5	21.3	19
20141-14-05	M14X1.5	8	05	45.5	4.5	22.2	19
20141-16-04	M16X1.5	6	04	44.7	4.5	23.2	22
20141-16-05	M16X1.5	8	05	45.8	4.5	22.5	22
20141-16-06	M16X1.5	10	06	47.4	4.5	24.1	22
20141-18-05T	M18X1.5	8	05	46.8	4	22.6	24
20141-18-06	M18X1.5	10	06	48.5	4	24.2	24
20141-18-08	M18X1.5	12	08	52.2	4	25.7	24
20141-20-06T	M20X1.5	10	06	48.2	5.5	23.9	27
20141-20-08	M20X1.5	12	08	62.1	5.5	27.2	27
20141-22-06T	M22X1.5	10	06	58.4	5	25.7	27
20141-22-08	M22X1.5	12	08	62.1	5	27.2	27
20141-24-08T	M24X1.5	12	08	61.1	5.5	26.1	30
20141-24-10	M24X1.5	16	10	75.4	5	29.6	30
20141-27-10DT	M27X1.5	16	10	74.4	5.5	29.6	32
20141-27-10T	M27X2	16	10	74.4	5.5	29.6	32
20141-30-12D	M30X1.5	20	12	80.9	6	33.5	36
20141-30-12	M30X2	20	12	80.9	6	33.5	36
20141-36-14T	M36X2	22	14	83	7	32.64	41
20141-39-16T	M39X2	25	16	88.2	7	33.95	46
20141-45-20T	M45X2	32	20	99.1	8.5	38.4	55
20141-52-24T	M52X2	40	24	114.1	9	43.4	60

注: 1. 上述代号用于编织软管。 2. 如需用于缠绕软管代号改为 20142-xx-xx。

NOTE : 1. FOR USE WITH BRAIDED HOSES 2. IF USE WITH SPIRAL HOSES , HOSE FITTINGS SERIES NUMBER IS 20142-XX-XX.

# 软管接头 HOSE FITTING

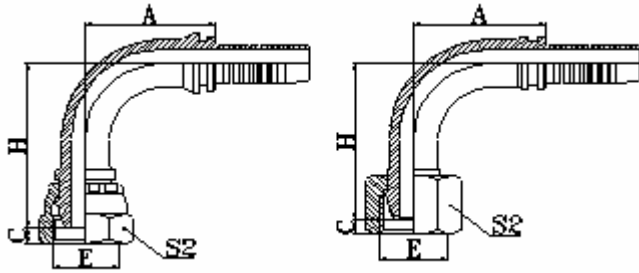

90° 公制内螺纹球面  
90° METRIC FEMALE MULTISEAL

20191

20191-T

代 号	螺纹 E	软 管		尺 寸			
		公 称 内 径	标 号	A	C	H	S2
20191-10-03	M10X1	5	03	27	2.5	35.5	14
20191-12-04	M12X1.5	6	04	30	4	37.5	17
20191-14-04	M14X1.5	6	04	27.5	4.5	38	19
20191-14-05	M14X1.5	8	05	33	4.5	41	19
20191-16-04	M16X1.5	6	04	27.5	4.5	38.5	19
20191-16-05	M16X1.5	8	05	31	4.5	43	22
20191-16-06	M16X1.5	10	06	35.3	4.5	43.8	22
20191-18-05T	M18X1.5	8	05	31	4	43	24
20191-18-06	M18X1.5	10	06	35.3	4	45.3	24
20191-18-08	M18X1.5	12	08	40.5	4	50.5	24
20191-20-06T	M20X1.5	10	06	35.3	5.5	43.8	24
20191-20-08	M20X1.5	12	08	41	5.5	52	27
20191-22-06T	M22X1.5	10	06	35.8	5	76.8	27
20191-22-08	M22X1.5	12	08	42.5	5	54.5	27
20191-24-08T	M24X1.5	12	08	41	5.5	51	30
20191-24-10	M24X1.5	16	10	58	5	58.5	30
20191-27-10DT	M27X1.5	16	10	56	5.5	55.5	32
20191-27-10T	M27X2	16	10	56	5.5	55.5	32
20191-30-12D	M30X1.5	20	12	67.5	6	68.5	36
20191-30-12	M30X2	20	12	67.5	6	68.5	36
20191-36-12T	M36X2	20	12	65.5	7	68	41
20191-36-14T	M36X2	22	14	71.2	7	69	4
20191-39-16T	M39X2	25	16	76.7	7	73.5	14
20191-45-20T	M45X2	32	20	91.5	8.5	85	655
20191-52-24T	M52X2	40	24	109.4	9	100	60
20191-64-32T	M64X2	50	32	131.75	14	122.3	75

注: 1. 上述代号用于编织软管。 2. 如需用于缠绕软管代号改为 20192-xx-xx。

NOTE : 1. FOR USE WITH BRAIDED HOSES 2. IF USE WITH SPIRAL HOSES , HOSE FITTINGS SERIES NUMBER IS 20192-XX-XX.

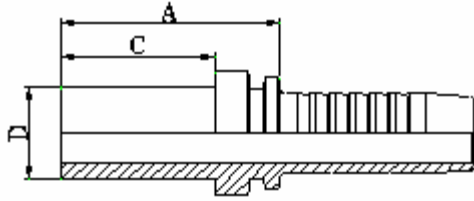

50011  
公制卡套式直管  
DIN2353  
METRIC STANDPIPE STRAIGHT

代 号	管子外径 D	软 管		尺 寸			备 注
		公称内径	标 号	A	C		
50011-06-03	6	5	03	28.5	22		轻系列
50011-06-04	6	6	04	29	22		
50011-10-05	10	8	05	31	23		
50011-10-06	10	10	06	32	23		
50011-12-06	12	10	06	32.5	23		
50011-12-08	12	12	08	33	23		
50011-15-06	15	10	06	35.5	25		
50011-15-08	15	12	08	35.5	25		
50011-18-08	18	12	08	36.5	26		
50011-18-10	18	16	10	41	26		
50011-22-10	22	16	10	44	28		
50011-22-12	22	20	12	44	28		
50011-22-16	22	25	16	46	28		
50011-28-16	28	25	16	47	30		
50011-35-20	35	32	20	56	36		
50011-42-24	42	40	24	62	40		
50011-08-04	8	6	04	31	24		重系列
50011-08-05	8	8	05	33	24		
50011-08-06	8	10	06	33	24		
50011-10-04	10	6	04	33	26		
50011-12-04	12	6	04	34.5	26		
50011-12-05	12	8	05	35.5	26		
50011-14-06	14	10	06	39.5	29		
50011-14-08	14	12	08	40	29		
50011-14-12	14	20	12	45.5	29		
50011-16-08	16	12	08	40.5	30		
50011-16-10	16	16	10	45.5	30		
50011-20-10	20	16	10	52	36		
50011-20-12	20	20	12	52.5	36		
50011-25-12	25	20	12	56	40		
50011-25-16	25	25	16	57	40		
50011-30-16	30	25	16	63	44		
50011-30-20	30	32	20	64	44		
50011-38-16	38	25	16	69	50		
50011-38-20	38	32	20	70	50		

注: 1. 上述代号用于编织软管。 2. 如需用于缠绕软管代号改为 50012-xx-xx。

NOTE : 1. FOR USE WITH BRAIDED HOSES 2. IF USE WITH SPIRAL HOSES , HOSE FITTINGS SERIES NUMBER IS 50012-XX-XX.



# 软管接头 HOSE FITTING

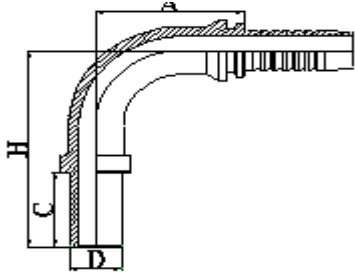

## 50091 90° 公制卡套式直管 90° METRIC STANDPIPE STRAIGHT DIN2353

代 号	管子外径 D	软 管		尺 寸			备 注
		公称内径	标 号	A	C	H	
50091-06-03	6	5	03	26.5	22	42.5	轻系列
50091-06-04	6	6	04	30	22	45.5	
50091-08-05	8	8	05	33	24	50.5	
50091-08-06	8	10	06	35.3	24	52.8	
50091-10-05	10	8	05	33	23	49.5	
50091-10-06	10	10	06	35.3	23	51.8	
50091-12-06	12	10	06	35.36	23	53.8	
50091-12-08	12	12	08	41	23	59	
50091-15-06	15	10	06	35.3	25	53.8	
50091-15-08	15	12	08	41	25	59	
50091-18-08	18	12	08	41	26	60	
50091-18-10	18	16	10	56.5	26	64.5	
50091-22-10	22	16	10	56.5	28	66.5	
50091-22-12	22	20	12	65.5	28	76	
50091-22-16	22	25	16	76.7	28	81.5	
50091-28-16	28	25	16	76.7	30	83.5	
50091-35-20	35	32	20	93	36	100.5	
50091-08-04	8	6	04	30	24	47.5	
50091-10-04	10	6	04	30	26	49.5	
50091-12-04	12	6	04	30	26	49.5	
50091-12-05	12	8	05	33	26	52.5	
50091-14-06	14	10	06	35.3	29	57.8	
50091-14-08	14	12	08	41	29	63	
50091-16-08	16	12	08	41	30	64	
50091-16-10	16	16	10	56.5	30	68.5	
50091-20-10	20	16	10	56.5	36	74.5	
50091-20-12	20	20	12	65.5	36	85	
50091-25-12	25	20	12	65.5	40	89	
50091-25-16	25	25	16	76.7	40	93.5	
50091-30-16	30	25	16	76.7	40	93.5	
50091-30-20	30	32	20	91.5	44	108.5	
50091-38-16	38	25	16	76.7	50	115.5	
50091-38-20	38	32	20	91.5	50	114.5	

注: 1.上述代号用于编织软管。 2. 如需用于缠绕软管代号改为 50092-xx-xx。

NOTE : 1. FOR USE WITH BRAIDED HOSES 2. IF USE WITH SPIRAL HOSES , HOSE FITTINGS SERIES NUMBER IS50092-XX-XX.

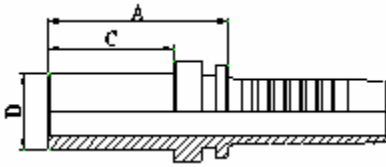

# 51011

国际卡套式直管

## BSP STANDARD PIPE

代 号	管子外径 D	软 管		尺 寸			
		公称内径	标 号		A	C	
51011-04-03	4	5			27	17	
51011-06-03	6	5			30.5	19	
51011-06-04	6	6			31	19	
51011-08-04	8	6			31	19	
51011-08-05	8	8			31.5	19	
51011-08-06	8	10			32	19	
51011-10-04	10	6			35	22	
51011-10-05	10	8			35	22	
51011-10-06	10	10			35	22	
51011-12-05	12	8			35	22	
51011-12-06	12	10			35	22	
51011-14-06	14	10			35	22	
51011-14-08	14	12			35.5	22	
51011-16-06	16	10			35	22	
51011-16-08	16	12			36	22	
51011-16-10	16	16			36.5	22	
51011-16-12	16	20			38	22	
51011-18-12	18	20			41.5	24	
51011-22-12	22	20			45	28	
51011-22-14	22	22			45	28	
51011-28-16	28	25			49	30	
51011-34-20	34	32			53	33	
51011-42-24	42	40			57	35	

注: 1.上述代号用于编织软管。 2. 如需用于缠绕软管代号改为 51012-xx-xx。

NOTE : 1. FOR USE WITH BRAIDED HOSES 2. IF USE WITH SPIRAL HOSES , HOSE FITTINGS SERIES NUMBER IS51012-XX-XX.

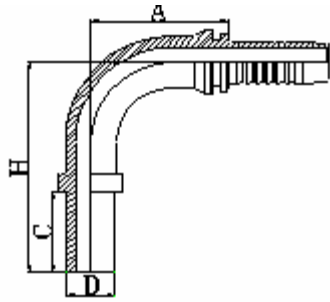

51091

90° 国际卡套式直管

90°BSP STANDARD PIPE

代 号	管子外径 D	软 管		尺 寸			
		公称内径	标 号		A	C	H
51091-06-04	6	6	04		30.5	19	42.5
51091-06-06	6	10	06		35.3	19	47.8
51091-08-04	8	6	04		30	19	42.5
51091-08-05	8	8	05		33	19	45.5
51091-10-04	10	6	04		30	22	45.5
51091-10-06	10	10	06		35.8	22	50.8
51091-12-06	12	10	06		35.3	22	50.8
51091-12-08	12	12	08		41	22	56
51091-14-06	14	10	06		35.3	22	50.8
51091-14-08	14	12	08		41	22	56
51091-15-10	15	16	10		56.5	26	64.5
51091-16-08	16	12	08		42	22	56
51091-16-10	16	16	10		56.5	22	60.5
51091-18-10	18	16	10		56.5	24	62.5
51091-18-12	18	20	12		64.9	24	72
51091-22-14	22	22	14		71.2	28	77
51091-28-16	28	25	16		76.7	30	83.5
51091-34-20	34	32	20		91.5	33	97.5
51091-42-24	42	40	24		109.4	35	113

注: 1.上述代号用于编织软管。 2. 如需用于缠绕软管代号改为 51092-xx-xx。

NOTE : 1. FOR USE WITH BRAIDED HOSES 2. IF USE WITH SPIRAL HOSES , HOSE FITTINGS SERIES NUMBER IS 51092-XX-XX.

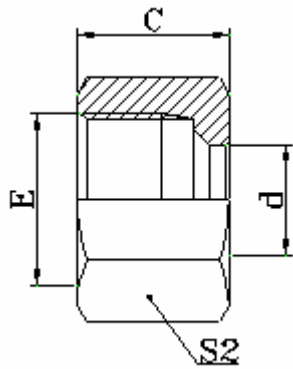

NL

NS

RETAINING NUT L.T.

卡套螺母

代 号	螺纹 E	管子外径		尺 寸			压力等级 MPa
				C	D	S2	
NL-12	M12X1.5	6		14.5	6	14	轻系列 L
NL-14	M14X1.5	8		14.5	8	17	
NL-16	M16X1.5	10		15.5	10	19	
NL-18	M18X1.5	12		15.5	12	22	
NL-22	M22X1.5	15		17	15	27	
NL-26	M26X1.5	18		18	18	32	
NL-30	M30X2	22		20	22	36	
NL-30D	M30X1.5	22		19	22	36	
NL-36	M36X2	28		21	28	41	
NL-36D	M36X1.5	28		21	28	41	
NL-45	M45X2	35		24	35	50	
NL-45D	M45X1.5	35		25	35	50	
NL-52	M52X2	42		24	42	60	
NS-14	M14X1.5	6		16.5	6	17	
NS-16	M16X1.5	8		16.5	8	19	
NS-18	M18X1.5	10		17.5	10	22	
NS-20	M20X1.5	12		17.5	12	24	
NS-22	M22X1.5	14		20.5	14	27	
NS-24	M24X1.5	16		20.5	16	30	
NS-30	M30X2	20		24	20	36	
NS-36	M36X2	25		27	25	46	
NS-42	M42X2	30		29	30	50	
NS-52	M52X2	38		32.5	38	60	

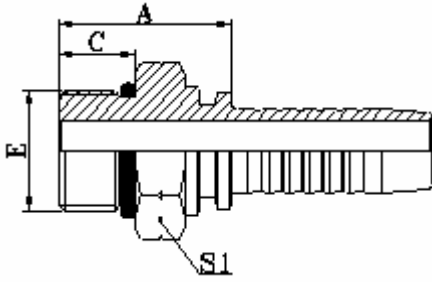

12211

BSP MALE O-RING SEAL

英管外螺纹 O 形圈密封

代 号	管子外径 D	软 管		O 形圈	尺 寸		
		公称内径	标 号		A	C	H
12211-04-04	G1/4"X19	6	04		24	11	19
12211-04-06	G1/4"X19	10	06		23.5	11	19
12211-06-06	G3/8"X19	10	06		26	12	22
12211-08-04	G1/2"X14	6	04		33.5	14	27
12211-08-06	G1/2"X14	10	06		33.5	14	27
12211-08-08	G1/2"X14	12	08		30	14	27
12211-10-10	G5/8"X14	16	10		34	15.5	30
12211-12-10	G3/4"X14	16	10		35	15.5	32
12211-12-12	G3/4"X14	20	12		35	15.5	32
12211-12-16	G3/4"X14	25	16		36	15.5	32
12211-16-16	G1"X11	25	16		41	18.5	41
12211-20-20	G1.1/4"X11	32	20		45	20	50

注: 1.上述代号用于编织软管。 2. 如需用于缠绕软管代号改为 12212-xx-xx。  
 NOTE : 1. FOR USE WITH BRAIDED HOSES 2. IF USE WITH SPIRAL HOSES , HOSE FITTINGS SERIES NUMBER IS 12212-XX-XX.



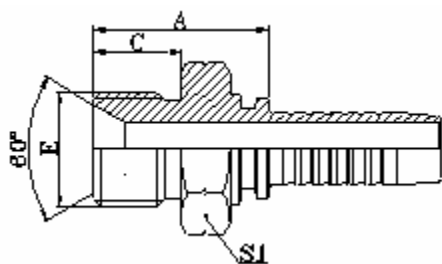

12611

BSP MALE 60° CONE SEAT

英管外螺纹 60° 内锥面

代 号	管子外径 D	软 管		尺 寸			
		公称内径	标 号	A	C	S1	
12611-02-03	G1/8"X28	5	03	22	10	12	
12611-04-04	G1/4"X19	6	04	24	12	14	
12611-06-05	G3/8"X19	8	05	26	13.5	17	
12611-06-06	G3/8"X19	10	06	26	13.5	17	
12611-06-08	G3/8"X19	12	08	26.5	13.5	19	
12611-08-06	G1/2"X14	10	06	30.5	16	22	
12611-08-08	G1/2"X14	12	08	30.5	16	22	
12611-10-08	G5/8"X14	12	08	32.5	17.5	24	
12611-10-10	G5/8"X14	16	10	34	17.5	24	
12611-12-08	G3/4"X14	12	08	35.5	18.5	27	
12611-12-10	G3/4"X14	16	10	37	18.5	27	
12611-12-12	G3/4"X14	20	12	36	18.5	27	
12611-16-12	G1"X11	20	12	40.5	20.5	36	
12611-16-16	G1"X11	25	16	42.5	20.5	36	
12611-20-16	G1.1/4"X11	25	16	43.5	20.5	46	
12611-20-20	G1.1/4"X11	32	20	44.5	20.5	46	
12611-24-20	G1.1/2"X11	32	20	49	23	50	
12611-24-24	G1.1/2"X11	40	24	49	23	50	
12611-32-32	G2"X11	50	32	54.5	25.5	65	

注: 1. 上述代号用于编织软管。 2. 如需用于缠绕软管代号改为 12612-xx-xx。

NOTE : 1. FOR USE WITH BRAIDED HOSES 2. IF USE WITH SPIRAL HOSES , HOSE FITTINGS SERIES NUMBER IS 12612-XX-XX.

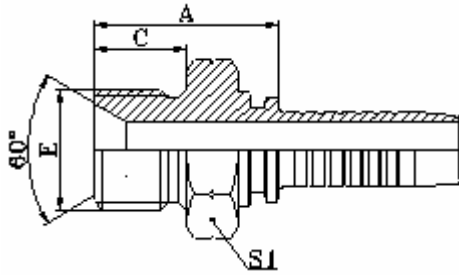

## 12611A

英管外螺纹 60° 内锥面或六角端面  
用组合垫密封的双用接头

BSP MALE DOUBLE USE FOR 60° CONE SEAT  
OR BONDED SEAL

代 号	管子外径 D	软 管		尺 寸			
		公称内径	标 号	A	C	S1	
12611A-02-03	G1/8"X28	5	03	22	10	14	
12611A-04-04	G1/4"X19	6	04	25	12	19	
12611A-04-05	G3/8"X19	8	05	25	12	19	
12611A-06-05	G3/8"X19	8	05	26	13.5	22	
12611A-06-06	G3/8"X19	10	06	27.5	13.5	22	
12611A-06-08	G3/8"X19	12	08	28.5	13.5	22	
12611A-08-06	G1/2"X14	10	06	33	16	27	
12611A-08-08	G1/2"X14	12	08	32	16	27	
12611A-08-10	G1/2"X14	16	10	32	16	27	
12611A-10-08	G5/8"X14	12	08	35	17.5	30	
12611A-10-10	G5/8"X14	16	10	36	17.5	30	
12611A-12-08	G3/4"X14	12	08	36.5	18.5	32	
12611A-12-10	G3/4"X14	16	10	37.5	18.5	32	
12611A-12-12	G3/4"X14	20	12	38	18.5	32	
12611A-16-12	G1"X11	20	12	42.5	20.5	41	
12611A-16-16	G1"X11	25	16	43	20.5	41	
12611A-20-16	G1.1/4"X11	25	16	45.5	20.5	50	
12611A-20-20	G1.1/4"X11	32	20	45.5	20.5	50	
12611A-24-24	G1.1/2"X11	40	24	50	23	55	
12611A-32-32	G2"X11	50	32	54.5	25.5	70	

注: 1. 上述代号用于编织软管。 2. 如需用于缠绕软管代号改为 12612A-xx-xx。

NOTE : 1. FOR USE WITH BRAIDED HOSES 2. IF USE WITH SPIRAL HOSES , HOSE FITTINGS  
SERIES NUMBER IS 12612A-XX-XX.

# 软管接头 HOSE FITTING

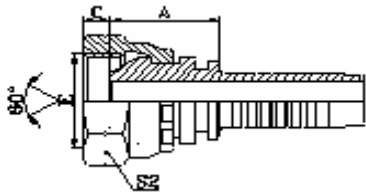

22611

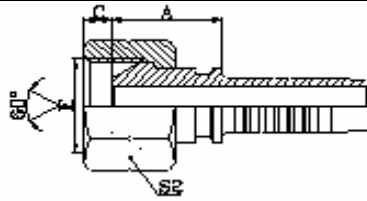

22611-T

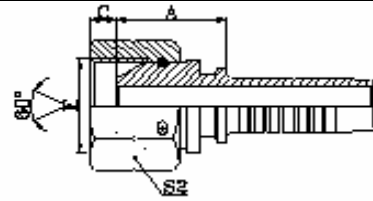

22611-W

英管内螺纹 60° 外锥面

BSP FEMALE 60° CONE

代 号	管子外径 D	软 管		尺 寸			
		公称内径	标 号	A	C	S2	
22611-02-03	G1/8"X28	5	03	15	5.5	14	
22611-02-04	G1/8"X28	6	04	17.5	5.5	14	
22611-04-03	G1/4"X19	5	03	17	5.5	19	
22611-04-04	G1/4"X19	6	04	19	5.5	19	
22611-04-05	G1/4"X19	8	05	19	5.5	19	
22611-04-06	G1/4"X19	10	06	19	5.5	19	
22611-06-04	G3/8"X19	6	04	21	6.3	22	
22611-06-05	G3/8"X19	8	05	21	6.3	22	
22611-06-06	G3/8"X19	10	06	21	6.3	22	
22611-06-08	G3/8"X19	12	08	21.5	6.3	22	
22611-08-06T	G1/2"X14	10	06	21	7.5	27	
22611-08-08	G1/2"X14	12	08	23	7.5	27	
22611-10-08	G5/8"X14	12	08	23.5	9.5	30	
22611-10-10	G5/8"X14	16	10	24.5	9.5	30	
22611-12-08T	G3/4"X14	12	08	22	10.9	32	
22611-12-10	G3/4"X14	16	10	24.5	10.9	32	
22611-12-12	G3/4"X14	20	12	24.5	10.9	32	
22611-16-12T	G1"X11	20	12	24	11.7	41	
22611-16-14	G1"X11	22	14	26	11.7	41	
22611-16-16	G1"X11	25	16	27.5	11.7	41	
22611-20-16T	G1.1/4"X11	25	16	27.5	11	50	
22611-20-20W	G1.1/4"X11	32	20	30.5	11	50	
22611-24-20T	G1.1/2"X11	32	20	32	13	55	
22611-24-24W	G1.1/2"X11	40	24	32	13	55	
22611-32-24T	G2"X11	40	24	30	16	70	
22611-32-32W	G2"X11	50	32	31.9	16	70	

注: 1. 上述代号用于编织软管。 2. 如需用于缠绕软管代号改为 22612-xx-xx。

NOTE : 1. FOR USE WITH BRAIDED HOSES 2. IF USE WITH SPIRAL HOSES , HOSE FITTINGS SERIES NUMBER IS 22612-XX-XX.

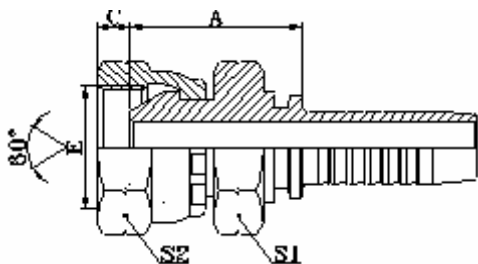

### 22611D

英管内螺纹 60° 外锥面双六角

BSP FEMALE 60°CONE DOUBLE HEXAGON

代 号	管子外径 D	软 管		尺 寸			
		公称内径	标 号	A	C	S1	S2
22611D-04-04	G1/4"X19	6	04	24.5	5.5	19	19
22611D-06-06	G3/8"X19	10	06	27	6.3	22	22
22611D-08-08	G1/2"X14	12	08	30.5	7.5	27	27
22611D-10-08	G5/8"X14	12	08	31	9.5	30	30
22611D-12-08	G3/4"X14	12	08	31.5	10.9	32	32
22611D-12-12	G3/4"X14	20	12	34.5	10.9	32	32
22611D-16-16	G1"X11	25	16	38.5	11.7	41	41
22611D-20-20W	G1.1/4"X11	32	20	44	11	50	50

注: 1.上述代号用于编织软管。 2. 如需用于缠绕软管代号改为 22612D-xx-xx。

NOTE : 1. FOR USE WITH BRAIDED HOSES 2. IF USE WITH SPIRAL HOSES , HOSE FITTINGS SERIES NUMBER IS 22612D-XX-XX.

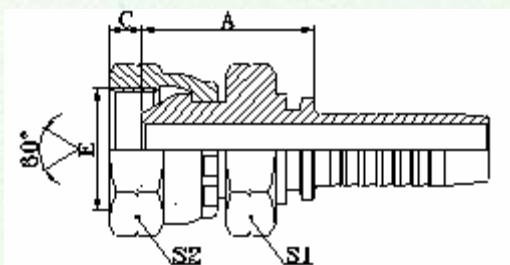

### 22611D-SM

英管内螺纹 60° 外锥面双六角

BSP FEMALE 60°CONE DOUBLE HEXAGON

代 号	管子外径 D	软 管		尺 寸			
		公称内径	标 号	A	C	S1	S2
22611D-04-04SM	G1/4"X19	6	04	23.5	5.5	12	19
22611D-06-06SM	G3/8"X19	10	06	24.5	6.3	17	22
22611D-08-08SM	G1/2"X14	12	08	29	7.5	22	27
22611D-10-08SM	G5/8"X14	12	08	29	9.5	22	30
22611D-12-08SM	G3/4"X14	12	08	31.5	10.9	27	32
22611D-12-12SM	G3/4"X14	20	12	33.5	10.9	27	32
22611D-16-16SM	G1"X11	25	16	35.5	11.7	32	41
22611D-20-20SM	G1.1/4"X11	32	20	42	11	41	50

注: 1.上述代号用于编织软管。 2. 如需用于缠绕软管代号改为 22612D-xx-xxSM。

NOTE : 1. FOR USE WITH BRAIDED HOSES 2. IF USE WITH SPIRAL HOSES , HOSE FITTINGS SERIES NUMBER IS 22612D-XX-XXSM.

# 软管接头 HOSE FITTING

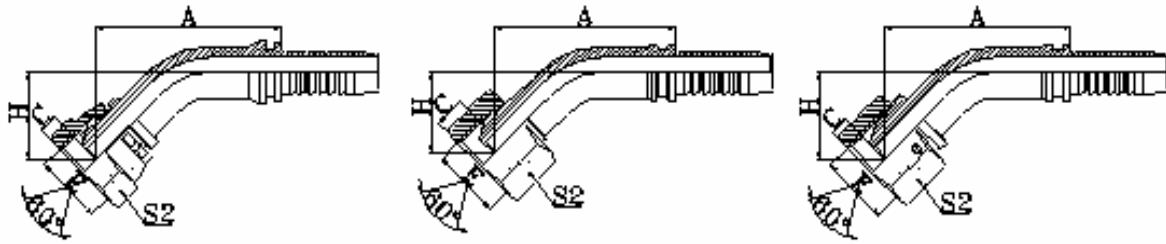

22641

22641-T

22641-W

45° 英管内螺纹 60° 外锥面

45°BSP FEMALE 60°CONE

代 号	管子外径 D	软 管		尺 寸			
		公称内径	标 号	A	C	H	S2
22641-04-04	G1/4"X19	6	04	40	5.5	21	19
22641-06-04	G3/8"X19	6	04	43.2	6.3	21	22
22641-06-05	G3/8"X19	8	05	45.3	6.3	22	22
22641-06-06	G3/8"X19	10	06	47	6.3	24	22
22641-08-06T	G1/2"X14	10	06	48.1	7.5	23.9	27
22641-08-08	G1/2"X14	12	08	59.5	7.5	27	27
22641-10-08	G5/8"X14	12	08	61.4	9.5	26.5	30
22641-10-10	G5/8"X14	16	10	63	9.5	29	30
22641-12-08T	G3/4"X14	12	08	61.8	10.9	26.9	32
22641-12-10	G3/4"X14	16	10	63	10.9	29	32
22641-12-12	G3/4"X14	20	12	75.5	10.9	32	32
22641-16-12T	G1"X11	20	12	80.8	11.7	33.4	41
22641-16-16	G1"X11	25	16	86	11.7	34	41
22641-20-16T	G1.1/4"X11	25	16	85.3	11	31.1	50
22641-20-20W	G1.1/4"X11	32	20	98.8	11	38	50
22641-24-24W	G1.1/2"X11	40	24	116.8	13	45.5	55
22641-32-32W	G2"X11	50	32	135.7	16	52.7	70

注: 1.上述代号用于编织软管。 2. 如需用于缠绕软管代号改为 22642-xx-xx。

NOTE : 1. FOR USE WITH BRAIDED HOSES 2. IF USE WITH SPIRAL HOSES , HOSE FITTINGS SERIES NUMBER IS 22642-XX-XX.



# 软管接头 HOSE FITTING

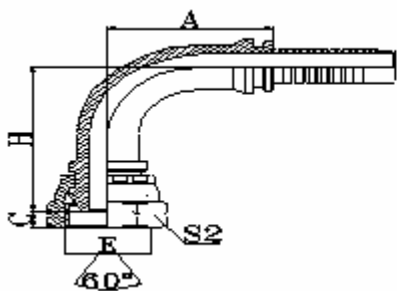

22691

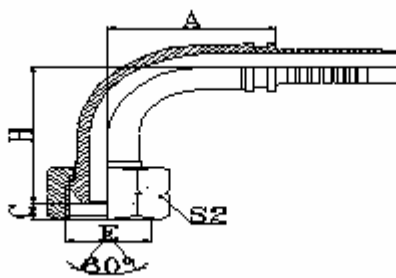

22691-T

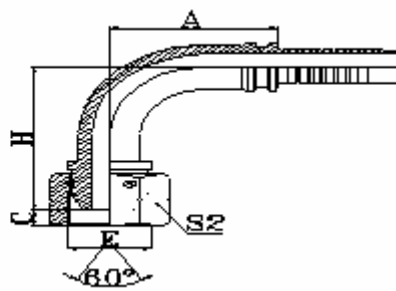

22691-W

90° 英管内螺纹 60° 外锥面

90°BSP FEMALE 60°CONE

代 号	管子外径 D	软 管		尺 寸			
		公称内径	标 号	A	C	H	S2
22691-02-03	G1/8"X28	5	03	26.5	5.5	31.5	14
22691-02-04	G1/8"X28	6	04	27.5	5.5	35.5	14
22691-04-03	G1/4"X19	5	03	26.5	5.5	33.5	19
22691-04-04	G1/4"X19	6	04	27.5	5.5	37	19
22691-04-05	G1/4"X19	8	05	31	5.5	41.5	19
22691-04-06	G1/4"X19	10	06	30	5.5	36.5	19
22691-06-04	G3/8"X19	6	04	27.5	6.3	39	22
22691-06-05	G3/8"X19	8	05	31	6.3	43.5	22
22691-06-06	G3/8"X19	10	06	33	6.3	44.5	22
22691-08-06T	G1/2"X14	10	06	35.3	7	43.3	27
22691-08-08	G1/2"X14	12	08	42.5	7.5	53	27
22691-08-10	G1/2"X14	16	10	56.5	7.5	55.5	27
22691-10-08	G5/8"X14	12	08	42.5	9.5	53.5	30
22691-10-10	G5/8"X14	16	10	48.5	9.5	58	30
22691-12-08T	G3/4"X14	12	08	41	10.9	52.1	32
22691-12-10	G3/4"X14	16	10	48.5	10.9	58	32
22691-12-12	G3/4"X14	20	12	50.5	10.9	66	32
22691-16-12T	G1"X11	20	12	65.5	11.7	68.3	41
22691-16-14	G1"X11	22	14	71.2	11.7	69.3	41
22691-16-16	G1"X11	25	16	66	11.7	78.5	41
22691-20-16T	G1.1/4"X11	25	16	78	11	69.5	50
22691-20-20W	G1.1/4"X11	32	20	91.5	11	84.3	50
22691-24-24W	G1.1/2"X11	40	24	109.4	13	103	55
22691-32-32W	G2"X11	50	32	131.8	16	123.3	70

注: 1.上述代号用于编织软管。 2. 如需用于缠绕软管代号改为 22692-xx-xx。

NOTE : 1. FOR USE WITH BRAIDED HOSES 2. IF USE WITH SPIRAL HOSES , HOSE FITTINGS SERIES NUMBER IS 22692-XX-XX.

## 22691 K

### BSP FEMALE CONE DOUBLE HEXAGON

90° 英管短身内螺纹 60° 外锥面

代 号	管子外径 D	软 管		尺 寸				
		公称内径	标 号	A	C	H	S1	S2
22691K-04-04	G1/4"X19	6	04	17.5	5.5	18.5	11	19
22691K-06-04	G3/8"X19	6	04	20	6.3	24	16	22
22691K-06-05	G3/8"X19	8	05	20	6.3	24	16	22
22691K-06-06	G3/8"X19	10	06	20	6.3	24	16	22
22691K-08-06	G1/2"X14	10	06	23	7.5	28.5	19	27
22691K-08-08	G1/2"X14	12	08	23.5	7.5	28.5	19	27
22691K-10-10	G5/8"X14	16	10	24.5	9.5	30.5	22	30
22691K-12-12	G3/4"X14	20	12	27.5	10.9	33	27	32
22691K-16-16	G1"X11	25	16	43	11.7	38.5	33	41

注: 1. 上述代号用于编织软管。 2. 如需用于缠绕软管代号改为 22692K-xx-xx。

NOTE : 1. FOR USE WITH BRAIDED HOSES 2. IF USE WITH SPIRAL HOSES , HOSE FITTINGS SERIES NUMBER IS 22692K-XX-XX.

# 软管接头 HOSE FITTING

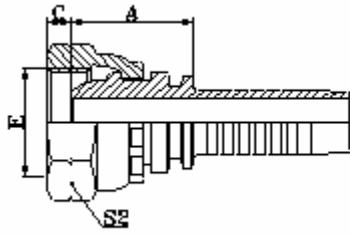

22111

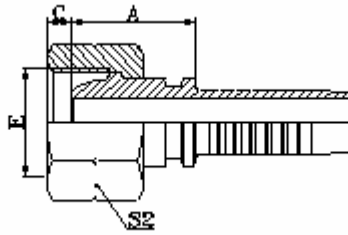

22111-T

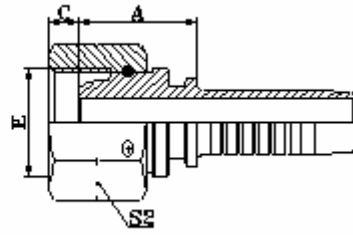

22111-W

英管内螺纹球面

BSP FEMALE MULTISEAL

代 号	螺纹 E	软 管			尺 寸			
		公称内径	标 号		A	C	S2	
22111-02-04	G1/8"X28	6	04		19	2	14	
22111-04-03	G1/4"X19	5	03		19	4	19	
22111-04-04	G1/4"X19	6	04		20.5	4	19	
22111-06-05	G3/8"X19	8	05		20	5	22	
22111-06-06	G3/8"X19	10	06		22.5	5	22	
22111-06-08	G3/8"X19	12	08		21	5	22	
22111-08-06T	G1/2"X14	10	06		22.5	6	27	
22111-08-08	G1/2"X14	12	08		25.5	6	27	
22111-08-10	G1/2"X14	16	10		24	6	27	
22111-10-10	G5/8"X14	16	10		26	8	30	
22111-10-12	G5/8"X14	20	12		25	8	30	
22111-12-08T	G3/4"X14	12	08		25	9.5	32	
22111-12-10	G3/4"X14	16	10		26	9.5	32	
22111-12-12	G3/4"X14	20	12		26	9.5	32	
22111-16-12T	G1"X11	20	12		26.5	11	41	
22111-16-14	G1"X11	22	14		26.5	11	41	
22111-16-16	G1"X11	25	16		28.5	11	41	
22111-20-16T	G1.1/4"X11	25	16		27.5	11	50	
22111-20-20W	G1.1/4"X11	32	20		31.5	10	50	
22111-24-24W	G1.1/2"X11	40	24		37	11.5	55	
22111-32-32W	G2"X11	50	32		34	15	70	

注: 1.上述代号用于编织软管。 2. 如需用于缠绕软管代号改为 22212-xx-xx。

NOTE : 1. FOR USE WITH BRAIDED HOSES 2. IF USE WITH SPIRAL HOSES , HOSE FITTINGS SERIES NUMBER IS 22212-XX-XX.

# 软管接头 HOSE FITTING

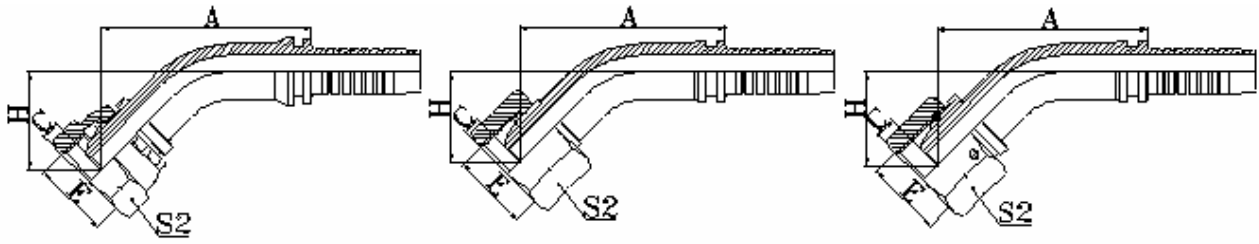

22141

22141-T

22141-W

45° 英管内螺纹球面

45°BSP FEMALE MULTISEAL

代 号	螺纹 E	软 管		尺 寸			
		公称内径	标 号	A	C	H	S2
22141-02-04	G1/8"X28	6	04	43.7	2	21.6	14
22141-04-03	G1/4"X19	5	03	41.3	4	20.4	19
22141-04-04	G1/4"X19	6	04	43.7	4	21.6	19
22141-06-05	G3/8"X19	8	05	46.2	5	22.9	22
22141-06-06	G3/8"X19	10	06	48.1	5	23.9	22
22141-06-08	G3/8"X19	12	08	60.4	5	25.4	22
22141-08-04T	G1/2"X14	6	04	43.9	6	23.8	27
22141-08-06T	G1/2"X14	10	06	42.5	6	18.2	27
22141-08-08	G1/2"X14	12	08	61.8	6	26.8	27
22141-08-10	G1/2"X14	16	10	73	6	29	27
22141-10-10	G5/8"X14	16	10	73.7	8	28.9	30
22141-10-12	G5/8"X14	20	12	79.8	8	32.5	30
22141-12-08T	G3/4"X14	12	08	63.2	9.5	28.3	32
22141-12-10	G3/4"X14	16	10	70.4	9.5	29.6	32
22141-12-12	G3/4"X14	20	12	80.6	9.5	33.2	32
22141-16-12	G1"X11	20	12	81.6	11	33.5	41
22141-16-14	G1"X11	22	14	83.3	11	33	41
22141-16-16	G1"X11	25	16	89.2	11	35	41
22141-20-16T	G1.1/4"X11	25	16	91.4	9.1	37.1	50
22141-20-20W	G1.1/4"X11	32	20	102.9	10	41.2	50
22141-24-24W	G1.1/2"X11	40	24	119.8	11.5	49	55
22141-32-32W	G2"X11	50	32	137.4	15	53	70

注: 1.上述代号用于编织软管。 2. 如需用于缠绕软管代号改为 22142-xx-xx。

NOTE : 1. FOR USE WITH BRAIDED HOSES 2. IF USE WITH SPIRAL HOSES , HOSE FITTINGS SERIES NUMBER IS22142-XX-XX.

# 软管接头 HOSE FITTING

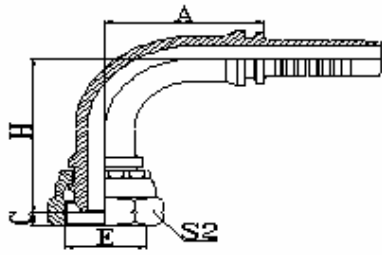

22191

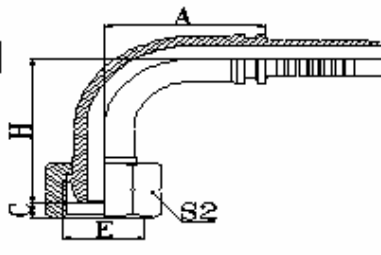

22191-T

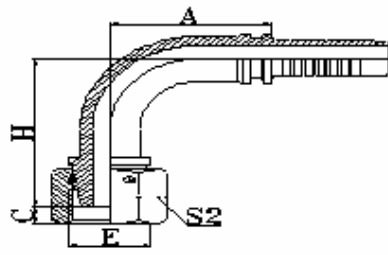

22191-W

90° 英管内螺纹球面

90°BSP FEMALE MULTISEAL

代 号	螺纹 E	软 管		尺 寸			
		公称内径	标 号	A	C	H	S2
22191-02-04	G1/8"X28	6	04	30	2	38	14
22191-04-03	G1/4"X19	5	03	27	4	35	19
22191-04-04	G1/4"X19	6	04	30	4	38	19
22191-04-05	G1/4"X19	8	05	33	4	41.5	19
22191-06-05	G3/8"X19	8	05	33	5	42	22
22191-06-06	G3/8"X19	10	06	35.3	5	44.3	22
22191-06-08	G3/8"X19	12	08	41	5	50	22
22191-08-06T	G1/2"X14	10	06	35.3	6	46.8	27
22191-08-08	G1/2"X14	12	08	41	6	52.5	27
22191-10-10	G5/8"X14	16	10	56.5	8	57.5	30
22191-10-12	G5/8"X14	20	12	65.5	8	67	30
22191-12-08T	G3/4"X14	12	08	41	9.5	52	32
22191-12-10	G3/4"X14	16	10	56.5	9.5	58.5	32
22191-12-12	G3/4"X14	20	12	65.5	9.5	68	32
22191-16-12T	G1"X11	20	12	66.2	11	68.5	41
22191-16-14	G1"X11	22	14	71.2	11	69.5	41
22191-16-16	G1"X11	25	16	76.7	11	75	41
22191-20-16T	G1.1/4"X11	25	16	76.7	10	78	50
22191-20-20W	G1.1/4"X11	32	20	92.3	10	85.3	50
22191-24-24W	G1.1/2"X11	40	24	109.4	11.5	108	55
22191-32-32W	G2"X11	50	32	133.1	15	123.8	70

注: 1.上述代号用于编织软管。 2. 如需用于缠绕软管代号改为 22192-xx-xx。

NOTE : 1. FOR USE WITH BRAIDED HOSES 2. IF USE WITH SPIRAL HOSES , HOSE FITTINGS SERIES NUMBER IS 22192-XX-XX.



# 软管接头 HOSE FITTING

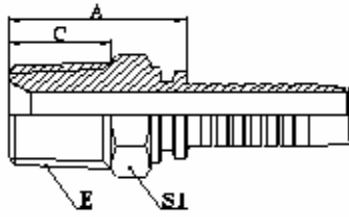

## 13011-SP

### 英锥管外螺纹

### BSP MALE

代 号	螺纹 E	软 管		尺 寸			
		公称内径	标 号	A	C	S1	
13011-02-03SP	R1/8"X28	5	03	22	10	12	
13011-02-04SP	R1/8"X28	6	04	22.5	10	12	
13011-04-04SP	R1/4"X19	6	04	27	14.5	14	
13011-04-05SP	R1/4"X19	8	05	25	15.4	14	
13011-04-06SP	R1/4"X19	10	06	27	14.5	17	
13011-06-04SP	R3/8"X19	6	04	27.5	15	17	
13011-06-05SP	R3/8"X19	8	05	26.5	15	17	
13011-06-06SP	R3/8"X19	10	06	27.5	15	17	
13011-06-08SP	R3/8"X19	12	08	30	15	19	
13011-08-06SP	R1/2"X14	10	06	34.5	20	22	
13011-08-08SP	R1/2"X14	12	08	35	20	22	
13011-08-10SP	R1/2"X14	16	10	38	20	22	
13011-08-12SP	R1/2"X14	20	12	38	20	27	
13011-12-08SP	R3/4"X14	12	08	37	20	27	
13011-12-10SP	R3/4"X14	16	10	38	20	27	
13011-12-12SP	R3/4"X14	20	12	38.5	20	27	
13011-12-16SP	R3/4"X14	25	16	39.5	20	32	
13011-16-12SP	R1"X11	20	12	44	25.5	36	
13011-16-16SP	R1"X11	25	16	45	25.5	36	
13011-20-20SP	R1.1/4"X11	32	20	49.5	26.5	46	
13011-24-24SP	R1.1/2"X11	40	24	52.5	26.5	50	
13011-32-24SP	R2"X11	40	24	57	30	65	
13011-32-32SP	R2"X11	50	32	59	30	65	

注: 1.上述代号用于编织软管。 2. 如需用于缠绕软管代号改为 13012-xx-xxSP。

NOTE : 1. FOR USE WITH BRAIDED HOSES 2. IF USE WITH SPIRAL HOSES , HOSE FITTINGS SERIES NUMBER IS 13012-XX-XXSP.

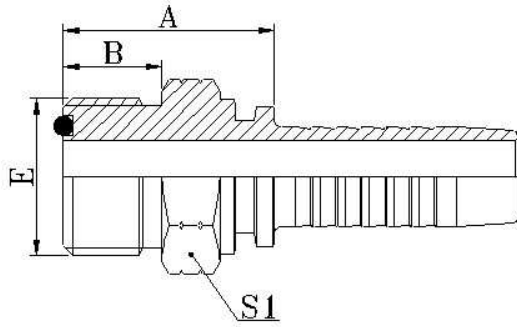

14211

美制 ORFS 外螺纹平面 O 形圈

ISO 8434-3—SAE J1453

ORFS MALE O-RING SEAL

代 号	螺纹 E	软 管		O 形圈	尺 寸			
		公称内径	标 号		A	C	S1	
14211-04-04	9/16"X18	6	04	O011	22.3	9.8	17	
14211-06-04	11/16"X16	6	04	O012	24.2	11.2	19	
14211-06-06	11/16"X16	10	06	O012	24.2	11.2	19	
14211-08-06	13/16"X16	10	06	O014	26.8	12.8	22	
14211-08-08	13/16"X16	12	08	O014	27.3	12.8	22	
14211-08-10	13/16"X16	16	10	O014	28.5	12.8	22	
14211-10-08	1"X14	12	08	O016	31.5	15.5	27	
14211-10-10	1"X14	16	10	O016	33	15.5	27	
14211-12-08	1.3/16"X12	12	08	O018	36.5	17	32	
14211-12-10	1.3/16"X12	16	10	O018	36	17	32	
14211-12-12	1.3/16"X12	20	12	O018	36.5	17	32	
14211-16-12	1.7/16"X12	20	12	O021	37	17.5	38	
14211-16-16	1.7/16"X12	25	16	O021	39.5	17.5	38	
14211-20-20	1.11/16"X12	32	20	O025	41.5	17.5	46	
14211-24-24	2"X12	40	24	O029	44.5	17.5	55	

注: 1.上述代号用于编织软管。 2. 如需用于缠绕软管代号改为 14212-xx-xx。

NOTE : 1. FOR USE WITH BRAIDED HOSES 2. IF USE WITH SPIRAL HOSES , HOSE FITTINGS SERIES NUMBER IS 14212-XX-XX.

# 软管接头 HOSE FITTING

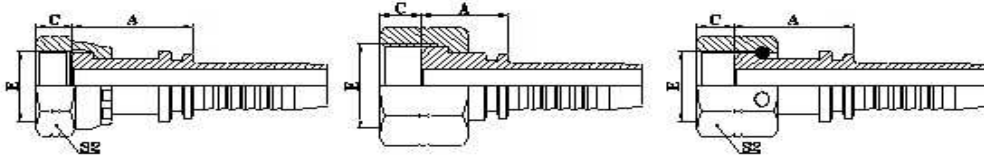

24211

24211-T

24211-W

美制 ORFS 内螺纹平面  
ORFS FEMALE FLAT SEAT  
ISO 12151-1—SAE J516

代 号	螺纹 E	软 管		尺 寸			
		公称内径	标 号	A	H	S2	
24211-04-04	9/16"X18	6	04	25.5	8.5	19	
24211-04-05	9/16"X18	8	05	22.5	8.5	19	
24211-04-06	9/16"X18	10	06	22.5	8.5	19	
24211-06-04T	11/16"X16	6	04	23.5	10	22	
24211-06-05T	11/16"X16	8	05	23.5	10	22	
24211-06-06	11/16"X16	10	06	26.5	10	22	
24211-06-08	11/16"X16	12	08	26	10	22	
24211-08-05T	13/16"X16	8	05	25	11	27	
24211-08-06T	13/16"X16	10	06	24.5	11	27	
24211-08-08	13/16"X16	12	08	28	11	27	
24211-08-10	13/16"X16	16	10	29	11	27	
24211-10-08T	1"X14	12	08	29	13.5	30	
24211-10-10	1"X14	16	10	34	13.5	30	
24211-10-12	1"X14	20	12	34	13.5	30	
24211-12-08T	1.3/16"X12	12	08	30.5	15	36	
24211-12-10T	1.3/16"X12	16	10	32.5	15	36	
24211-12-12	1.3/16"X12	20	12	36.5	15	36	
24211-12-16	1.3/16"X12	25	16	36	15	36	
24211-16-12T	1.7/16"X12	20	12	32.5	14.8	41	
24211-16-14T	1.7/16"X12	22	14	35	14.8	41	
24211-16-16T	1.7/16"X12	25	16	34.3	14.8	41	
24211-16-20	1.7/16"X12	32	20	39.5	14.8	41	
24211-20-16T	1.11/16"X12	25	16	34.5	15	50	
24211-20-20W	1.11/16"X12	32	20	42.5	15	50	
24211-20-24W	1.11/16"X12	40	24	42.5	15	50	
24211-24-20T	2"X12	32	20	36	14.8	60	
24211-24-24T	2"X12	40	24	37.2	14.8	60	

注: 1. 上述代号用于编织软管。 2. 如需用于缠绕软管代号改为 24212-xx-xx。

NOTE : 1. FOR USE WITH BRAIDED HOSES 2. IF USE WITH SPIRAL HOSES , HOSE FITTINGS SERIES NUMBER IS24212-XX-XX

# 软管接头 HOSE FITTING

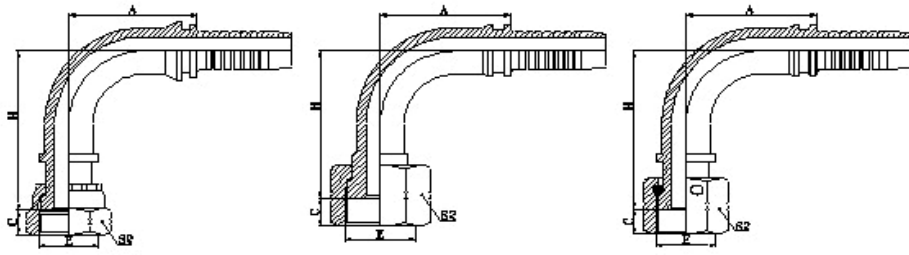

24291

24291-T

24291-W

90° 美制 ORFS 内螺纹平面  
90°ORFS FEMALE FLAT SEAT  
ISO 12151-1—SAE J516

代 号	螺纹 E	软 管		尺 寸			
		公称内径	标 号	A	H	C	S2
24291-04-04	9/16"X18	6	04	27.5	43.5	8.5	19
24291-04-05	9/16"X18	8	05	33	44	8.5	19
24291-06-05T	11/16"X16	8	05	33	37.5	10	22
24291-06-06	11/16"X16	10	06	33	50	10	22
24291-08-08	11/16"X16	12	08	42.5	55	10	22
24291-08-06T	13/16"X16	10	06	35.3	39.8	11	27
24291-08-08	13/16"X16	12	08	41	58	11	27
24291-08-10	13/16"X16	16	10	56.5	61.5	11	27
24291-10-08T	1"X14	12	08	41	46	13.5	30
24291-10-10	1"X14	16	10	48.5	67.5	13.5	30
24291-10-12	1"X14	20	12	50.5	75.5	13.5	30
24291-12-10T	1.3/16"X12	16	10	56	51.5	15	36
24291-12-12	1.3/16"X12	20	12	65.5	78	15	36
24291-12-16	1.3/16"X12	25	16	76.7	83.5	15	36
24291-16-12T	1.7/16"X12	20	12	65.5	63	14.8	41
24291-16-14T	1.7/16"X12	22	14	71.2	63	14.8	41
24291-16-16T	1.7/16"X12	25	16	76.9	67.5	14.8	41
24291-20-16T	1.11/16"X12	25	16	76.7	67.5	15	50
24291-20-20W	1.11/16"X12	32	20	93	100	15	50
24291-24-20T	2"X12	32	20	91.5	78.5	14.8	60
24291-24-24T	2"X12	40	24	109.4	92	14.8	60

注: 1.上述代号用于编织软管。 2. 如需用于缠绕软管代号改为 24292-xx-xx。

NOTE : 1. FOR USE WITH BRAIDED HOSES 2. IF USE WITH SPIRAL HOSES , HOSE FITTINGS SERIES NUMBER IS 24292-XX-XX.



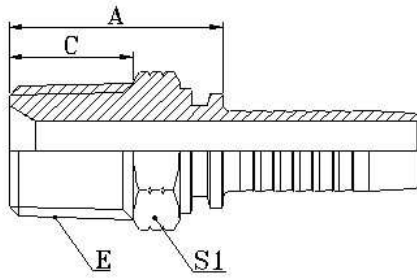

15611

美制布锥管外螺纹

NPT MALE

代 号	螺纹 E	软 管		尺 寸			
		公称内径	标 号	A	C	S1	
15611-02-03	Z1/8"X27	5	03	21.5	10.5	12	
15611-02-04	Z1/8"X27	6	04	22.5	10.5	12	
15611-04-03	Z1/4"X18	5	03	27	15	17	
15611-04-04	Z1/4"X18	6	04	27.5	15	17	
15611-04-05	Z1/4"X18	8	05	27.5	15	17	
15611-04-06	Z1/4"X18	10	06	27.5	15	17	
15611-06-04	Z3/8"X18	6	04	29	16	19	
15611-06-05	Z3/8"X18	8	05	29	16	19	
15611-06-06	Z3/8"X18	10	06	29	16	19	
15611-06-08	Z3/8"X18	12	08	29.5	16	19	
15611-08-06	Z1/2"X14	10	06	33.5	19.5	22	
15611-08-08	Z1/2"X14	12	08	34	19.5	22	
15611-08-10	Z1/2"X14	16	10	35.5	19.5	22	
15611-12-08	Z3/4"X14	12	08	37	19.5	27	
15611-12-10	Z3/4"X14	16	10	37	19.5	27	
15611-12-12	Z3/4"X14	20	12	38.5	19.5	27	
15611-12-16	Z3/4"X14	25	16	39.5	19.5	32	
15611-16-10	Z1"X11.5	16	10	45	25.5	36	
15611-16-12	Z1"X11.5	20	12	45	25.5	36	
15611-16-16	Z1"X11.5	25	16	47.5	25.5	36	
15611-20-16	Z1.1/4"X11.5	25	16	49	26.5	46	
15611-20-20	Z1.1/4"X11.5	32	20	50.5	26.5	46	
15611-24-24	Z1.1/2"X11.5	40	24	53.5	27.5	50	
15611-32-32	Z2"X11.5	50	32	56.5	27.5	65	

注: 1.上述代号用于编织软管。 2. 如需用于缠绕软管代号改为 15612-xx-xx。

NOTE : 1. FOR USE WITH BRAIDED HOSES 2. IF USE WITH SPIRAL HOSES , HOSE FITTINGS SERIES NUMBER IS 15612-XX-XX.



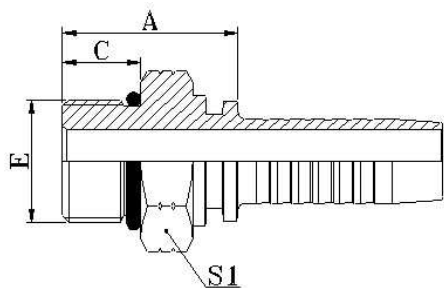

16011

美制 SAE 外螺纹带 O 形圈

SAE O-RING SEAL

ISO 11962-SAE J1926

代 号	螺纹 E	软 管		O 形圈	尺 寸		
		公称内径	标 号		A	C	S1
16011-04-04	7/16"X20	6	04	O904	21.5	9.1	14
16011-05-04	1/2"X20	6	04	O905	21.5	9.1	17
16011-06-05	9/16"X18	8	05	O906	22.5	9.9	17
16011-06-06	9/16"X18	10	06	O906	22.5	9.9	17
16011-08-06	3/4"X16	10	06	O908	23.5	11.1	22
16011-08-08	3/4"X16	12	08	O908	24	11.1	22
16011-10-08	7/8"X14	12	08	O910	30	12.7	27
16011-10-10	7/8"X14	16	10	O910	31	12.7	27
16011-12-10	1.1/16"X12	16	10	O912	34	15.1	32
16011-12-12	1.1/16"X12	20	12	O912	34	15.1	32
16011-16-16	1.5/16"X12	25	16	O916	36	15.1	38

注: 1.上述代号用于编织软管。 2. 如需用于缠绕软管代号改为 16012-xx-xx。

NOTE : 1. FOR USE WITH BRAIDED HOSES 2. IF USE WITH SPIRAL HOSES , HOSE FITTINGS SERIES NUMBER IS 16012-XX-XX.

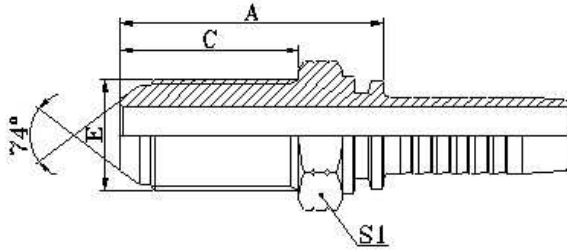

16711L

JIC 74°MALE CONE SEAL LONGER

美制 JIC 外螺纹 74° 外锥面

代 号	螺纹 E	软 管		尺 寸			
		公称内径	标 号	A	C	S1	
16711L-04-04	7/16"X20	6	04	43	30.5	17	
16711L-05-04	1/2"X20	6	04	43	30.5	19	
16711L-05-05	1/2"X20	8	05	43	30.5	19	
16711L-06-04	9/16"X18	6	04	47	32.5	22	
16711L-06-05	9/16"X18	8	05	47	32.5	22	
16711L-06-06	9/16"X18	10	06	47	32.5	22	
16711L-08-06	3/4"X16	10	06	51	36.5	24	
16711L-08-08	3/4"X16	12	08	51.5	36.5	24	
16711L-10-06	7/8"X14	10	06	56.5	40	30	
16711L-10-08	7/8"X14	12	08	57	40	30	
16711L-10-10	7/8"X14	16	10	58	40	30	
16711L-12-08	1.1/16"X12	12	08	63	44.5	36	
16711L-12-10	1.1/16"X12	16	10	64	44.5	36	
16711L-12-12	1.1/16"X12	20	12	64	44.5	36	
16711L-16-12	1.5/16"X12	20	12	66	44.5	41	
16711L-16-16	1.5/16"X12	25	16	67	44.5	41	
16711L-20-16	1.5/8"X12	25	16	70.5	45.7	50	
16711L-20-20	1.5/8"X12	32	20	71.2	45.7	50	
16711L-24-20	1.7/8"X12	32	20	71.5	46	55	
16711L-24-24	1.7/8"X12	40	24	71.5	46	55	

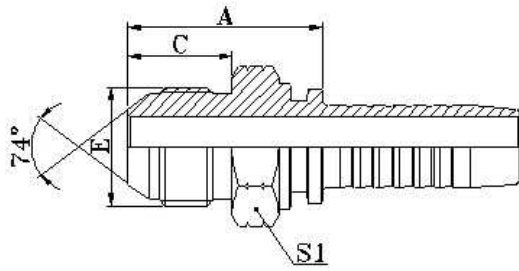

16711  
美制 JIC 外螺纹 74° 外锥面  
JIC 74° MALE CONE SEAL

代 号	螺纹 E	软 管		尺 寸			
		公称内径	标 号	A	C	S1	
16711-04-03	7/16"X20	5	03	26	14	12	
16711-04-04	7/16"X20	6	04	26	14	12	
16711-05-04	1/2"X20	6	04	26	14	14	
16711-05-05	1/2"X20	8	05	26	14	14	
16711-05-06	1/2"X20	10	06	26.5	14	17	
16711-06-04	9/16"X18	6	04	26.6	14.1	17	
16711-06-05	9/16"X18	8	05	26.6	14.1	17	
16711-06-06	9/16"X18	10	06	26.6	14.1	17	
16711-08-06	3/4"X16	10	06	30.7	16.7	22	
16711-08-08	3/4"X16	12	08	31.2	16.7	22	
16711-10-06	7/8"X14	10	06	34.3	19.3	24	
16711-10-08	7/8"X14	12	08	34	19.3	24	
16711-10-10	7/8"X14	16	10	35.8	19.3	24	
16711-12-08	1.1/16"X12	12	08	38.5	21.9	30	
16711-12-10	1.1/16"X12	16	10	39.4	21.9	30	
16711-12-12	1.1/16"X12	20	12	39.4	21.9	30	
16711-12-16	1.1/16"X12	25	16	42	21.9	30	
16711-14-10	1.3/16"X12	16	10	41.5	22.6	32	
16711-14-12	1.3/16"X12	20	12	40.5	22.6	32	
16711-16-12	1.5/16"X12	20	12	43.6	23.1	36	
16711-16-16	1.5/16"X12	25	16	45.1	23.1	36	
16711-20-16	1.5/8"X12	25	16	47	24.3	46	
16711-20-20	1.5/8"X12	32	20	48.3	24.3	46	
16711-24-20	1.7/8"X12	32	20	53	27.5	50	
16711-24-24	1.7/8"X12	40	24	53.5	27.5	50	
16711-32-32	2.1/2"X12	50	32	62.9	33.9	65	

注: 1. 上述代号用于编织软管。 2. 如需用于缠绕软管代号改为 16712-xx-xx。

NOTE : 1. FOR USE WITH BRAIDED HOSES 2. IF USE WITH SPIRAL HOSES , HOSE FITTINGS SERIES NUMBER IS 16712-XX-XX.

# 软管接头 HOSE FITTING

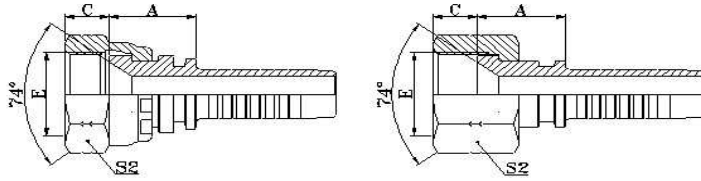

美制 JIC 外螺纹 74° 内锥面

26711

26711-T

JIC FEMALE 74° CONE SEAT

代 号	螺纹 E	软 管		尺 寸			
		公称内径	标 号	A	C	S2	
26711-04-03	7/16"X20	5	03	14.5	9	15	
26711-04-04	7/16"X20	6	04	15	9	15	
26711-05-04	1/2"X20	6	04	16	9.5	17	
26711-05-05	1/2"X20	8	05	16	9.5	17	
26711-05-06	1/2"X20	10	06	16.5	9.5	17	
26711-06-04	9/16"X18	6	04	16.5	10.5	19	
26711-06-05	9/16"X18	8	05	16	10.5	19	
26711-06-06	9/16"X18	10	06	16.5	10.5	19	
26711-06-08	9/16"X18	12	08	16	10.5	19	
26711-08-06	3/4"X16	10	06	18	11	24	
26711-08-08	3/4"X16	12	08	18.5	11	24	
26711-08-10	3/4"X16	16	10	19.5	11	24	
26711-10-08	7/8"X14	12	08	19.5	13	27	
26711-10-10	7/8"X14	16	10	20.5	13	27	
26711-10-12	7/8"X14	20	12	20	13	7	
26711-12-08T	1.1/16"X12	12	08	19	15	32	
26711-12-10	1.1/16"X12	16	10	21.5	15	32	
26711-12-12	1.1/16"X12	20	12	21.5	15	32	
26711-12-16	1.1/16"X12	25	16	23.5	15	32	
26711-14-12	1.3/16"X12	20	12	21.5	15	36	
26711-16-12T	1.5/16"X12	20	12	18.5	16	41	
26711-16-16	1.5/16"X12	25	16	24.5	16	41	
26711-16-20	1.5/16"X12	32	20	24	16	41	
26711-20-16T	1.5/8"X12	25	16	23	17	50	
26711-20-20W	1.5/8"X12	32	20	26	17	50	
26711-24-20W	1.7/8"X12	32	20	26.5	20	55	
26711-24-24W	1.7/8"X12	40	24	26.5	20	55	
26711-32-24T	2.1/2"X12	40	24	27	23.5	75	
26711-32-32T	2.1/2"X12	50	32	27	23.5	75	

注: 1. 上述代号用于编织软管。 2. 如需用于缠绕软管代号改为 26712-xx-xx。

NOTE : 1. FOR USE WITH BRAIDED HOSES 2. IF USE WITH SPIRAL HOSES , HOSE FITTINGS SERIES NUMBER IS26712-XX-XX.

# 软管接头 HOSE FITTING

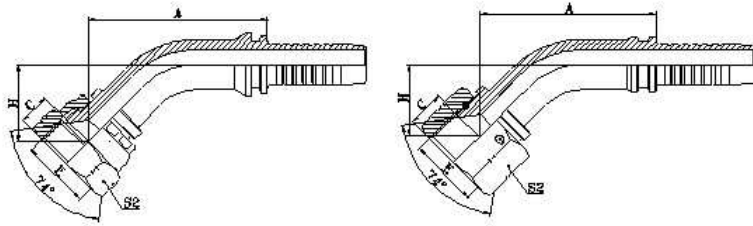

45° 美制 JIC 内螺纹  
74° 内锥面 SAE J514  
45° JIC FEMALE 74° CONE  
SEAT

26741

26741-W

代 号	螺纹 E	软 管		尺 寸			
		公称内径	标 号	A	C	H	S2
26741-04-03	7/16"X20	5	03	37.6	9	17.2	15
26741-04-04	7/16"X20	6	04	37	9	18	15
26741-05-04	1/2"X20	6	04	40.5	9.5	18.5	17
26741-05-05	1/2"X20	8	05	41.5	9.5	20	17
26741-05-06	1/2"X20	10	06	44.6	9.5	20.3	17
26741-06-04	9/16"X18	6	04	40.5	10.5	18.5	19
26741-06-05	9/16"X18	8	05	42	10.5	20.5	19
26741-06-06	9/16"X18	10	06	44	10.5	20.5	19
26741-08-06	3/4"X16	10	06	45	11	21.5	24
26741-08-08	3/4"X16	12	08	56.5	11	24	24
26741-10-08	7/8"X14	12	08	57.5	13	24.6	27
26741-10-10	7/8"X14	16	10	60	13	26	27
26741-10-12	7/8"X14	20	12	75.7	13	28.9	27
26741-12-08	1.1/16"X12	12	08	58	15	25.5	32
26741-12-10	1.1/16"X12	16	10	60.5	15	27	32
26741-12-12	1.1/16"X12	20	12	73.5	15	30	32
26741-14-12	1.3/16"X12	20	12	77.4	15	30	36
26741-16-12	1.5/16"X12	20	12	77.4	16	30	41
26741-16-16	1.5/16"X12	25	16	84	16	32.5	41
26741-20-20W	1.5/8"X12	32	20	95.9	17	35.2	50
26741-24-20W	1.7/8"X12	32	20	100.9	20	40.1	55
26741-24-24W	1.7/8"X12	40	24	114.8	20	44.1	55
26741-32-32T	2.1/2"X12	50	32	135.9	23.5	51.6	75

注: 1.上述代号用于编织软管。 2. 如需用于缠绕软管代号改为 26742-xx-xx。

NOTE : 1. FOR USE WITH BRAIDED HOSES 2. IF USE WITH SPIRAL HOSES , HOSE FITTINGS SERIES NUMBER IS26742-XX-XX.



# 软管接头 HOSE FITTING

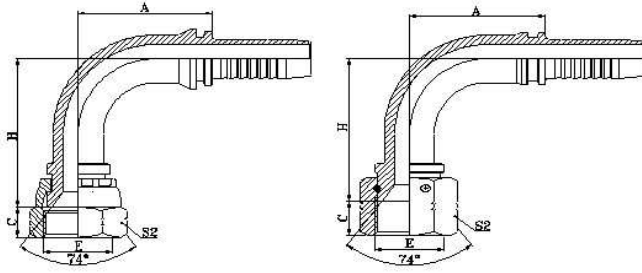

90° 美制 JIC 内螺纹  
74° 内锥面 SAE J514  
90° JIC FEMALE 74° CONE  
SEAT

26791

26791-W

代 号	螺纹 E	软 管		尺 寸			
		公称内径	标 号	A	C	H	S2
26791-04-03	7/16"X20	5	03	26.5	9	30.5	15
26791-04-04	7/16"X20	6	04	27.5	9	33	15
26791-05-04	1/2"X20	6	04	27.5	9.5	33.5	17
26791-05-05	1/2"X20	8	05	31	9.5	38.5	17
26791-05-06	1/2"X20	10	06	35.3	9.5	39.3	17
26791-06-04	9/16"X18	6	04	27.5	10.5	34.5	19
26791-06-05	9/16"X18	8	05	31	10.5	39	19
26791-06-06	9/16"X18	10	06	33	10.5	40	19
26791-06-08	9/16"X18	12	08	35.8	10.5	39.8	19
26791-08-06	3/4"X16	10	06	33	11	41.5	24
26791-08-08	3/4"X16	12	08	42.5	11	48.5	24
26791-08-10	3/4"X16	16	10	49	11	47.5	24
26791-10-08	7/8"X14	12	08	42.5	13	49.5	27
26791-10-10	7/8"X14	16	10	48.5	13	54	27
26791-10-12	7/8"X14	20	12	50.5	13	62	27
26791-12-08	1.1/16"X12	12	08	42.5	15	50.5	32
26791-12-10	1.1/16"X12	16	10	48.5	15	55	32
26791-12-12	1.1/16"X12	20	12	60.5	15	63	32
26791-12-16	1.1/16"X12	25	16	74	15	63.5	32
26791-14-12	1.3/16"X12	20	12	65.5	15	63.5	36
26791-16-12	1.5/16"X12	20	12	65.5	16	63.5	41
26791-16-16	1.5/16"X12	25	16	66	16	75.5	41
26791-20-20W	1.5/8"X12	32	20	91.5	17	80.5	50
26791-24-20W	1.7/8"X12	32	20	91.5	20	80.5	55
26791-24-24W	1.7/8"X12	40	24	109.4	20	94	55
26791-32-32T	2.1/2"X12	50	32	133.1	23.5	121.8	75

注: 1.上述代号用于编织软管。 2. 如需用于缠绕软管代号改为 26792-xx-xx。

NOTE : 1. FOR USE WITH BRAIDED HOSES 2. IF USE WITH SPIRAL HOSES , HOSE FITTINGS SERIES NUMBER IS 26792-XX-XX.

## 26791K

90° 美制短身 JIC 内螺纹

74° 内锥面 SAE J514

90° JIC COMPACT FEMALE 74° CONE SEAT

代 号	螺 纹 E	软 管		尺 寸				
		公称内径	标 号	A	C	H	S1	S2
26791K-04-04	7/16"X20	6	04	17.5	9	18	11	15
26791K-06-04	9/16"X18	6	04	20	10.5	20.5	14	19
26791K-06-06	9/16"X18	10	06	20	10.5	20.5	16	19
26791K-08-06	3/4"X16	10	06	23	11	25	19	24
26791K-08-08	3/4"X16	12	08	23.5	11	25	22	24
26791K-10-08	7/8"X14	12	08	25	13	27	22	27
26791K-10-10	7/8"X14	16	10	25	13	27	22	27
26791K-12-12	1.1/16"X12	20	12	29	15	31	27	32
26791K-16-16	1.5/16"X12	25	16	43	16	34.3	33	41

注: 1.上述代号用于编织软管。 2. 如需用于缠绕软管代号改为 26792K-xx-xx。

NOTE : 1. FOR USE WITH BRAIDED HOSES 2. IF USE WITH SPIRAL HOSES , HOSE FITTINGS SERIES NUMBER IS 26792K-XX-XX.

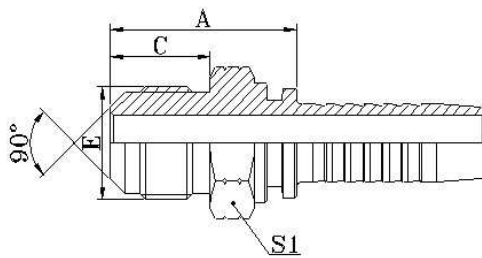

## 17811

美制 SAE 外螺纹 90° 外锥面

SAE MALE 90° CONE

代 号	螺 纹 E	软 管		尺 寸			
		公称内径	标 号	A	C	S1	
17811-04-04	7/16"X20	6	04	25.5	12.7	12	
17811-05-05	1/2"X20	8	05	27	14.2	14	
17811-06-06	5/8"X18	10	06	28.5	15.7	17	
17811-08-08	3/4"X16	12	08	34	19	22	
17811-10-10	7/8"X14	16	10	38.5	22.4	24	
17811-12-12	1.1/16"X14	20	12	44	25.4	30	

注: 1.上述代号用于编织软管。 2. 如需用于缠绕软管代号改为 17812-xx-xx。

NOTE : 1. FOR USE WITH BRAIDED HOSES 2. IF USE WITH SPIRAL HOSES , HOSE FITTINGS SERIES NUMBER IS 17812-XX-XX.

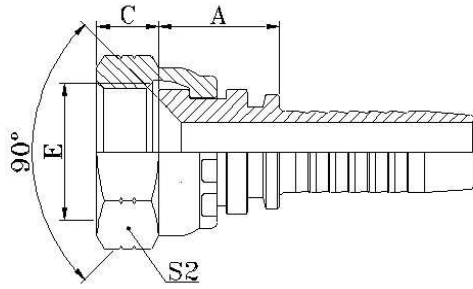

## 27811

美制 SAE 内螺纹  
90° 内锥面 SAE J513  
SAE FEMALE 90° CONE SEAT

代 号	螺 纹 E	软 管		尺 寸			
		公称内径	标 号	A	C	S2	
27811-04-03	7/16"X20	5	03	14	9	15	
27811-04-04	7/16"X20	6	04	15	9	15	
27811-05-05	1/2"X20	8	05	16	9.5	17	
27811-06-04	5/8"X18	6	04	17	11.3	22	
27811-06-05	5/8"X18	8	05	17	11.3	22	
27811-06-06	5/8"X18	10	06	17	11.3	22	
27811-08-08	3/4"X16	12	08	18.5	11	24	
27811-10-08	7/8"X14	12	08	18.5	13	27	
27811-10-10	7/8"X14	16	10	20.5	13	27	
27811-12-12	1.1/16"X14	20	12	21.5	14.3	32	

注: 1. 上述代号用于编织软管。 2. 如需用于缠绕软管代号改为 27812-xx-xx。

NOTE : 1. FOR USE WITH BRAIDED HOSES 2. IF USE WITH SPIRAL HOSES , HOSE FITTINGS SERIES NUMBER IS 27812-XX-XX.

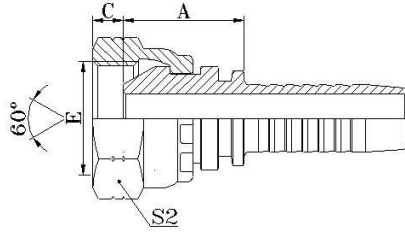

**21611**  
 美制 NPSM 内螺纹  
 NPSM FEMALE 60° CONE  
 60° 外锥面 SAE J514

代 号	螺纹 E	软 管		尺 寸			
		公称内径	标 号	A	B	S2	
21611-04-04	1/4"X18	6	04	18	4.6	19	
21611-04-06	1/4"X18	10	06	19	4.6	19	
21611-06-04	3/8"X18	6	04	19	6	22	
21611-06-05	3/8"X18	8	05	19	6	22	
21611-06-06	3/8"X18	10	06	19	6	22	
21611-08-08	1/2"X14	12	08	21.5	7.5	27	
21611-12-10	3/4"X14	16	10	24	8.9	32	
21611-12-12	3/4"X14	20	12	24	8.9	32	
21611-16-12T	1"X11.5	20	12	25	10.5	41	
21611-16-16	1"X11.5	25	16	27	10.5	41	
21611-20-20W	1.1/4"X11.5	32	20	29.5	11.2	50	
21611-24-24W	1.1/2"X11.5	40	24	29.5	11.2	55	

注: 1.上述代号用于编织软管。 2. 如需用于缠绕软管代号改为 21612-xx-xx。

NOTE : 1. FOR USE WITH BRAIDED HOSES 2. IF USE WITH SPIRAL HOSES , HOSE FITTINGS SERIES NUMBER IS21612-XX-XX.

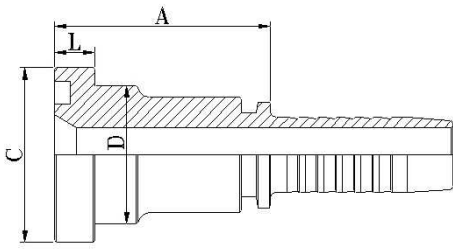

87312  
SAE 法兰 3000PSI  
SAE FLANGE 3000 PSI  
ISO 12151-3—SAE J516

代 号	法兰型号	软 管		尺 寸			
		公称内径	标 号	A	C	D	L
87312-08-08	1/2"	12	08	45.5	30.2	24	6.73
87312-12-08	3/4"	12	08	47.5	38.1	31.7	6.73
87312-12-10	3/4"	16	10	49	38.1	31.7	6.73
87312-12-12	3/4"	20	12	48.5	38.1	31.7	6.73
87312-12-16	3/4"	25	16	49	38.1	31.7	6.73
87312-16-12	1"	20	12	51	44.4	38	8
87312-16-16	1"	25	16	48	44.4	38	8
87312-16-20	1"	32	20	53	44.4	38	8
87312-20-16	1.1/4"	25	16	57	50.8	43	8
87312-20-20	1.1/4"	32	20	56	50.8	43	8
87312-24-20	1.1/2"	32	20	68	60.3	50	8
87312-24-24	1.1/2"	40	24	74	60.3	50	8
87312-32-24	2"	40	24	70	71.4	62	9.53
87312-32-32	2"	50	32	70	71.4	62	9.53
87312-40-40	2.1/2"	64	40	76	84.1	74	9.53

注: 1.上述代号用于编织软管。 2. 如需用于缠绕软管代号改为 87312-xx-xx。  
NOTE : 1. FOR USE WITH BRAIDED HOSES 2. IF USE WITH SPIRAL HOSES , HOSE FITTINGS SERIES NUMBER IS 87312-XX-XX.



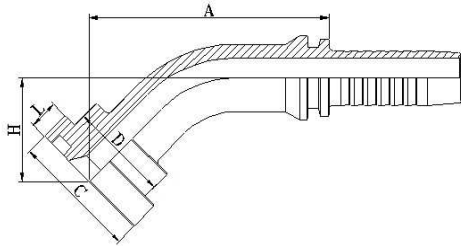

**87342**  
 45° SAE 法兰 3000PSI  
 45°SAE FLANGE 3000 PSI  
 ISO 12151-3—SAE J516

代 号	法兰型号	软 管		尺 寸				
		公称内径	标 号	A	C	D	H	L
87342-08-08	1/2"	12	08	56.5	30.2	24	23.5	6.73
87342-12-08	3/4"	12	08	58.9	38.1	31.7	24	6.73
87342-12-10	3/4"	16	10	69.9	38.1	31.7	25.3	6.73
87342-12-12	3/4"	20	12	73.5	38.1	31.7	29.5	6.73
87342-16-12	1"	20	12	76.3	44.4	38	28.9	8
87342-16-16	1"	25	16	83.	44.4	38	31	8
87342-16-20	1"	32	20	94.5	44.4	38	33.8	8
87342-20-16	1.1/4"	25	16	82	50.8	43	30.5	8
87342-20-20	1.1/4"	32	20	95	50.8	43	36	8
87342-24-20	1.1/2"	32	20	95.9	60.3	50	35.2	8
87342-24-24	1.1/2"	40	24	108	60.3	50	42	8
87342-32-24	2"	40	24	109.9	71.4	62	39.1	9.53
87342-32-32	2"	50	32	129.3	71.1	62	43	9.53

注: 1.上述代号用于编织软管。 2. 如需用于缠绕软管代号改为 87342-xx-xx。

NOTE : 1. FOR USE WITH BRAIDED HOSES 2. IF USE WITH SPIRAL HOSES , HOSE FITTINGS SERIES NUMBER IS 87342-XX-XX.

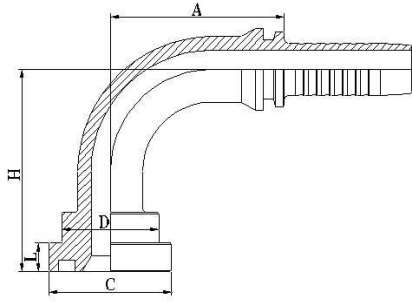

**87392**  
**90° SAE 法兰 3000PSI**  
**90°SAE FLANGE 3000 PSI**  
**ISO 12151-3—SAE J516**

代 号	法兰型号	软 管		尺 寸				
		公称内径	标 号	A	C	D	H	L
87392-08-08	1/2"	12	08	42.5	30.2	24	48	6.73
87392-12-08	3/4"	12	08	42.5	38.1	31.7	50	6.73
87392-12-10	3/4"	16	10	56	38.1	31.7	52.5	6.73
87392-12-12	3/4"	20	12	60.5	38.1	31.7	62.5	6.73
87392-12-16	3/4"	25	16	76.7	38.1	31.7	67.5	6.73
87392-16-12	1"	20	12	65.5	44.4	38	62	8
87392-16-16	1"	25	16	66	44.4	38	74	8
87392-16-20	1"	32	20	91.5	44.4	38	78.5	8
87392-20-16	1.1/4"	25	16	76.7	50.8	43	67.5	8
87392-20-20	1.1/4"	32	20	75	50.8	43	86	8
87392-20-24	1.1/4"	40	24	107	50.8	43	78.5	8
87392-24-20	1.1/2"	32	20	75	60.3	50	90	8
87392-24-24	1.1/2"	40	24	89	60.3	50	102	8
87392-32-24	2"	40	24	109.4	71.4	62	94	9.53
87392-32-32	2"	50	32	115.5	71.4	62	129.5	9.53
87392-40-40	2.1/2"	64	40	131.8	84.1	74.4	116.3	9.53

注: 1.上述代号用于编织软管。 2. 如需用于缠绕软管代号改为 87392-xx-xx。

NOTE : 1. FOR USE WITH BRAIDED HOSES 2. IF USE WITH SPIRAL HOSES , HOSE FITTINGS SERIES NUMBER IS 87392-XX-XX.

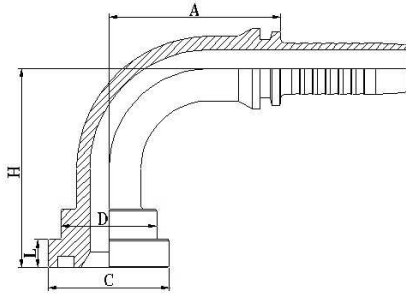

87392-H

90° SAE 法兰 3000PSI

90°SAE FLANGE SPECIAL HEIGHT

代 号	法兰型号	软 管		尺 寸				
		公称内径	标 号	A	C	D	H	L
87392-12-12(H90)	3/4"	20	12	65.5	38.1	32	90	6.73
87392-12-12(H100)	3/4"	20	12	65.5	38.1	32	100	6.73
87392-12-12(H127)	3/4"	20	12	65.5	38.1	32	127	6.73
87392-12-12(H150)	3/4"	20	12	65.5	38.1	32	150	6.73
87392-16-16(H100)	1"	25	16	76.7	44.4	38	100	8
87392-16-16(H127)	1"	25	16	76.7	44.4	38	127	8
87392-16-16(H150)	1"	25	16	76.7	44.4	38	150	8
87392-20-20(H100)	1.1/4"	32	20	91.5	50.8	43	100	8
87392-20-20(H157)	1.1/4"	32	20	91.5	50.8	43	127	8
87392-20-20(H150)	1.1/4"	32	20	91.5	50.8	43	150	8
87392-24-24(H127)	1.1/2"	40	24	109.4	50.8	50	127	8

FL 3000 PSI HALF FLANGE

FS 6000 PSI HALF FLANGE

SAE 对开法兰夹

代 号	法兰型号	尺 寸							压力等级 Mpa	
		A	B	D	H	M	N			
3000PSI										
FL-08	1/2"		54	45.6	9	6.2	38.1	17.5	M8X25	34.5
FL-12	3/4"		65	51.8	11	6.2	47.6	22.2	M10X30	
FL-16	1"		70	58.4	11	7.5	52.4	26.2	M10X30	
FL-20	1.1/4"		79	72.6	11	7.5	58.7	30.5	M10X30	27.6
FL-24	1.1/2"		91	82.2	13.5	7.5	69.9	35.7	M12X35	20.7
FL-32	2"		102	96.4	13.5	9	77.8	42.9	M12X35	
FL-40	2.1/2"		114	108.2	13.5	9	88.9	50.8	M12X40	17.2
FL-48	3"		135	130.6	17.5	9	106.4	61.9	M16X50	13.8
6000PSI										
FS-08	1/2"		56	47.2	9	7.2	40.5	18.2	M8X30	42
FS-12	3/4"		71	60	11	8.2	50.8	23.8	M10X35	
FS-16	1"		81	69.6	13.5	9	57.2	27.8	M12X45	
FS-20	1.1/4"		95	77.2	13.5	9.8	66.6	31.8	M12X45	
FS-24	1.1/2"		113	95	17.5	12	79.3	36.5	M16X55	
FS-32	2"		133	113.8	22	12	96.8	44.5	M20X70	

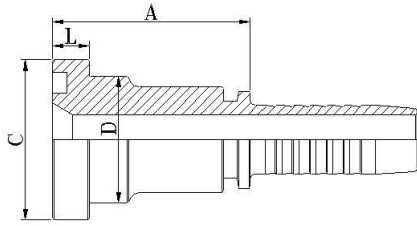

87612

SAE 法兰 6000PSI

SAE FLANGE 6000 PSI

ISO 12151-3—SAE J516

代 号	法兰型号	软 管		尺 寸				
		公称内径	标 号	A	C	D	L	
87612-08-08	1/2"	12	08	47.5	31.7	24	7.75	
87612-12-10	3/4"	16	10	50.5	41.3	32	8.76	
87612-12-12	3/4"	20	12	51.5	41.3	32	8.76	
87612-16-12	1"	20	12	56	47.6	38	9.53	
87612-16-16	1"	25	16	52.5	47.6	38	9.53	
87612-16-20	1"	32	20	61	47.6	38	9.53	
87612-20-16	1.1/4"	25	16	65	54	44	10.29	
87612-20-20	1.1/4"	32	20	62	54	44	10.29	
87612-24-20	1.1/2"	32	20	75	63.5	51	12.57	
87612-24-24	1.1/2"	40	24	79	63.5	51	12.57	
87612-32-24	2"	40	24	85	79.4	67	12.57	
87612-32-32	2"	50	32	79	79.4	67	12.57	

注: 1. 上述代号用于编织软管。 2. 如需用于缠绕软管代号改为 87612-xx-xx。

NOTE : 1. FOR USE WITH BRAIDED HOSES 2. IF USE WITH SPIRAL HOSES , HOSE FITTINGS SERIES NUMBER IS 87612-XX-XX.



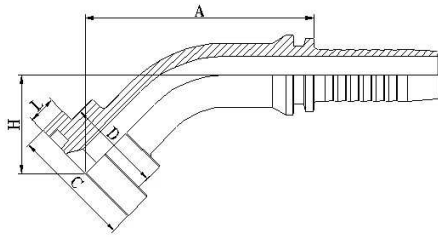

## 87642

45° SAE 法兰 6000PSI

45° SAE FLANGE 6000 PSI

ISO 12151-3—SAE J516

代 号	法兰型号	软 管		尺 寸				
		公称内径	标 号	A	C	D	H	L
87642-08-08	1/2"	12	08	57.5	31.7	24	25	7.75
87642-08-12	1/2"	20	12	77	31.7	24	29.6	7.75
87642-12-10	3/4"	16	10	72.5	41.3	32	28.2	8.76
87642-12-12	3/4"	20	12	75.5	41.3	32	32	8.76
87642-16-16	1"	25	16	86	47.6	38	34.	9.53
87642-20-20	1.1/4"	32	20	100	54	44	40	10.29
87642-24-20	1.1/2"	32	20	105.8	63.5	51	45.1	12.57
87642-24-24	1.1/2"	40	24	112	63.5	51	46	12.57
87642-32-24	2"	40	24	125.4	79.4	67	54.7	12.57
87642-32-32	2"	50	32	143	79.4	67	49	12.57

注: 1.上述代号用于编织软管。 2. 如需用于缠绕软管代号改为 87642-xx-xx。

NOTE : 1. FOR USE WITH BRAIDED HOSES 2. IF USE WITH SPIRAL HOSES , HOSE FITTINGS SERIES NUMBER IS 87642-XX-XX.

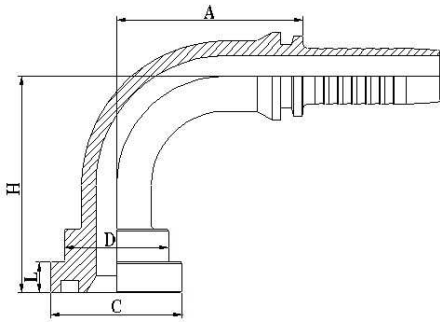

87692

90° SAE 法兰 6000PSI

90° SAE FLANGE 6000 PSI

ISO 12151-3—SAE J516

代 号	法兰型号	软 管		尺 寸				
		公称内径	标 号	A	C	D	H	L
87692-08-08	1/2"	12	08	42.5	31.7	24	50	7.75
87692-12-10	3/4"	16	10	56	41.3	32	56.5	8.76
87692-12-12	3/4"	20	12	50.5	41.3	32	65.5	8.76
87692-16-12	1"	20	12	65.5	47.6	38	69	9.53
87692-16-16	1"	25	16	66	47.6	38	78	9.53
87692-16-20	1"	32	20	91.5	47.6	38	85.5	9.53
87692-20-16	1.1/4"	25	16	76.7	54	44	78.5	10.29
87692-20-20	1.1/4"	32	20	75	54	44	92	10.29
87692-24-20	1.1/2"	32	20	91.5	63.5	51	94.5	12.57
87692-24-24	1.1/2"	40	24	89	63.5	51	107	12.57
87692-32-24	2"	40	24	109.4	79.4	67	116	12.57
87692-32-32	2"	50	32	115.5	79.4	67	138.5	12.57

注: 1.上述代号用于编织软管。 2. 如需用于缠绕软管代号改为 87692-xx-xx。

NOTE : 1. FOR USE WITH BRAIDED HOSES 2. IF USE WITH SPIRAL HOSES , HOSE FITTINGS SERIES NUMBER IS 87692-XX-XX.

# 软管接头 HOSE FITTING

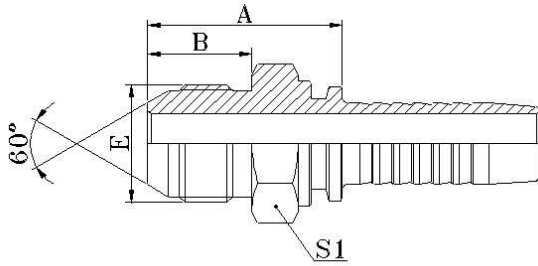

## 18611

日本公制外螺纹 60° 外锥面

JIS METRIC MALE 60° CONE SEAT

代 号	螺纹 E	软 管		尺 寸			
		公称内径	标 号	A	B	S1	
18611-14-04	M14X1.5	6	04	29.5	17	17	
18611-16-04	M16X1.5	6	04	30.5	18	17	
18611-16-06	M16X1.5	10	06	30.5	18	17	
18611-18-06	M18X1.5	10	06	30.5	18	19	
18611-20-08	M20X1.5	12	08	35	20	22	
18611-22-08	M22X1.5	12	08	35.5	20	24	
18611-24-10	M24X1.5	16	10	39.5	21.5	27	
18611-30-12	M30X1.5	20	12	45.5	26	32	
18611-33-16	M33X1.5	25	16	50.5	30	36	
18611-36-20	M36X1.5	32	20	56.5	33	38	
18611-42-24	M42X1.5	40	24	59.5	36	46	

注: 1.上述代号用于编织软管。 2. 如需用于缠绕软管代号改为 18612-xx-xx。  
 NOTE : 1. FOR USE WITH BRAIDED HOSES 2. IF USE WITH SPIRAL HOSES , HOSE FITTINGS SERIES NUMBER IS 18612-XX-XX.

# 软管接头 HOSE FITTING

日本公制内螺纹 60° 内锥面  
JIC METRIC FEMALE 60°  
CONE SEAT

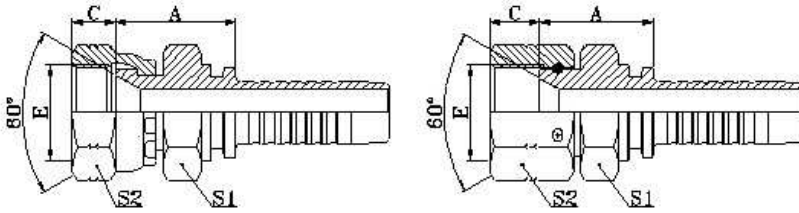

28611

28611-W

代 号	螺纹 E	软 管		尺 寸			
		公称内径	标 号	A	B	S1	S2
28611-12-14	M12X1.5	6	04	20	9	17	17
28611-14-04W	M14X1.5	6	04	23	10.5	19	19
28611-14-06	M14X1.5	10	06	21	10.5	19	19
28611-16-04	M16X1.5	6	04	24	10	22	22
28611-16-05	M16X1.5	8	05	24	10	22	22
28611-16-06	M16X1.5	10	06	24	10	22	22
28611-18-06	M18X1.5	10	06	24	11.5	24	24
28611-18-08	M18X1.5	12	08	24.5	11.5	24	24
28611-20-08	M20X1.5	12	08	28.5	12	27	27
28611-22-08	M22X1.5	12	08	25.5	14	27	27
28611-24-08	M24X1.5	12	08	27.5	15	32	32
28611-24-10	M24X1.5	16	10	28	15	32	32
28611-30-12	M30X1.5	20	12	28.5	18.3	36	36
28611-33-12	M33X1.5	20	12	31	21.3	41	41
28611-33-16	M33X1.5	25	16	32	21.3	41	41
28611-36-20	M36X1.5	32	20	35.5	20	46	46
28611-42-24W	M42X1.5	40	24	36	18.8	55	55

注: 1.上述代号用于编织软管。 2. 如需用于缠绕软管代号改为 28612-xx-xx。

NOTE : 1. FOR USE WITH BRAIDED HOSES 2. IF USE WITH SPIRAL HOSES , HOSE FITTINGS SERIES NUMBER IS 28612-XX-XX.

# 软管接头 HOSE FITTING

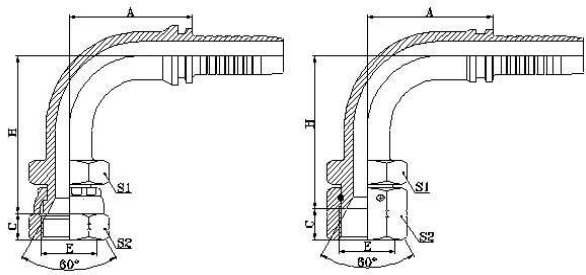

90° 日本公制内螺纹 60° 内锥面  
90° JIS METRIC FEMALE 60° CONE SEAT

28691

28691-W

代 号	螺纹 E	软 管		尺 寸				
		公称内径	标 号	A	B	H	S1	S2
28691-14-04W	M14X1.5	6	04	30	10.5	40	19	19
28691-14-06	M14X1.5	10	06	35.3	10.5	43.3	19	19
28691-16-05	M16X1.5	8	05	33	10	44	22	22
28691-18-06	M18X1.5	10	06	35.3	11.5	46.3	24	24
28691-22-08	M22X1.5	12	08	41	14	52.5	27	27
28691-24-10	M24X1.5	16	10	56	15	59	32	32
28691-30-12	M30X1.5	20	12	65.5	18.3	71.5	36	36
28691-33-16	M33X1.5	25	16	76.7	21.3	76	41	41
28691-36-20	M36X1.5	32	20	93	20	89	46	46
28691-42-24W	M42X1.5	40	24	109.4	18.8	108	55	55

注: 1. 上述代号用于编织软管。 2. 如需用于缠绕软管代号改为 28692-xx-xx。

NOTE : 1. FOR USE WITH BRAIDED HOSES 2. IF USE WITH SPIRAL HOSES , HOSE FITTINGS SERIES NUMBER IS 28692-XX-XX.



19611

日本英制外螺纹 60° 外锥面

JIS GAS FEMALE 60° CONE SEAT

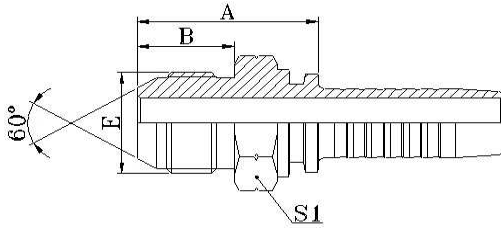

代 号	螺纹 E	软 管		尺 寸			
		公称内径	标 号	A	B	S1	
19611-04-04	G1/4"X19	3	04	29	16	17	
19611-06-06	G3/8"X19	10	06	31	18	19	
19611-08-08	G1/2"X14	12	08	35.5	20	22	
19611-12-12	G3/4"X14	20	12	41	22	30	
19611-16-16	G1"X11	25	16	45.5	24	36	

注: 1.上述代号用于编织软管。 2. 如需用于缠绕软管代号改为 19612-xx-xx。

NOTE : 1. FOR USE WITH BRAIDED HOSES 2. IF USE WITH SPIRAL HOSES , HOSE FITTINGS SERIES NUMBER IS 19612-XX-XX.

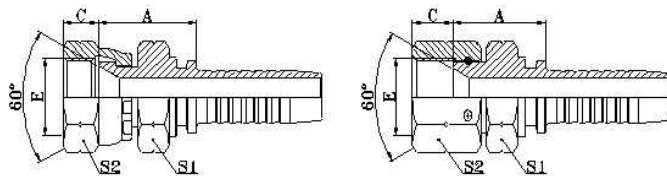

日本英制内螺纹 60° 内锥面

JIS GAS FEMALE 60° CONE SEAT

JIS B8363

29611

29611-W

代 号	螺纹 E	软 管		尺 寸			
		公称内径	标 号	A	C	S1	S2
29611-02-03	G1/8"X28	5	03	20	7	14	14
29611-04-04	G1/4"X19	6	04	21	8	19	19
29611-04-05	G1/4"X19	8	05	21	8	19	19
29611-06-04	G3/8"X19	6	04	23	9	22	22
29611-06-06	G3/8"X19	10	06	23	9	22	22
29611-08-06	G1/2"X14	10	06	28	12	27	27
29611-08-08	G1/2"X14	12	08	26.5	12	27	27
29611-10-10	G5/8"X14	16	10	30.5	11.5	30	30
29611-12-10	G3/4"X14	16	10	30	13.5	32	32
29611-12-12	G3/4"X14	20	12	30.5	13.5	32	32
29611-16-16	G1"X11	25	16	32	16	41	41
29611-20-20W	G1.1/4"X11	32	20	43	18.5	50	50
29611-24-24W	G1.1/2"X11	40	24	43.5	19	55	55
29611-32-32W	G2"X11	50	32	46.5	23	70	70

注: 1.上述代号用于编织软管。 2. 如需用于缠绕软管代号改为 29612-xx-xx。

NOTE : 1. FOR USE WITH BRAIDED HOSES 2. IF USE WITH SPIRAL HOSES , HOSE FITTINGS SERIES NUMBER IS 29612-XX-XX.

# 软管接头 HOSE FITTING

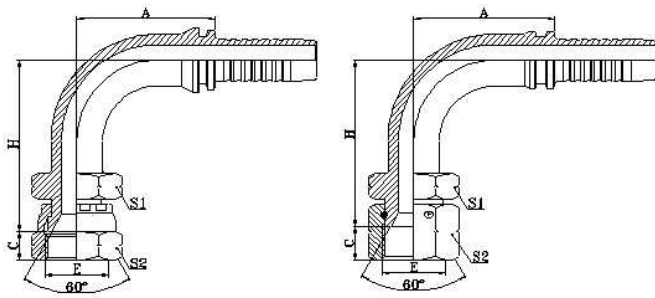

90° 日本英管内螺纹  
 60° 内锥面 JIS B8363  
 90° JIS GAS FEMALE 60°  
 CONE SEAT

29691

29691-W

代 号	螺纹 E	软 管		尺 寸				
		公称内径	标 号	A	C	H	S1	S2
29691-04-04	G1/4"X19	6	04	30	8	38	19	19
29691-04-05	G1/4"X19	8	05	34	8	41	19	19
29691-06-06	G3/8"X19	10	06	35.6	9	45.8	22	22
29691-08-08	G1/2"X14	12	08	41	12	53	27	27
29691-10-10	G5/8"X14	16	10	56.5	11.5	61	30	30
29691-12-12	G3/4"X14	20	12	65.5	13.5	69	32	32
29691-16-16	G1"X11	25	16	76.7	16	76.5	41	41
29691-20-20W	G1.1/4"X11	32	20	91.5	18.5	92.5	50	50
29691-24-24W	G1.1/2"X11	40	24	109.4	19	110.5	55	55
29691-32-32W	G2"X11	50	32	131.8	23	133.8	70	70

注: 1. 上述代号用于编织软管。 2. 如需用于缠绕软管代号改为 29692-xx-xx。

NOTE : 1. FOR USE WITH BRAIDED HOSES 2. IF USE WITH SPIRAL HOSES , HOSE FITTINGS SERIES NUMBER IS 29692-XX-XX.

# 软管接头 HOSE FITTING

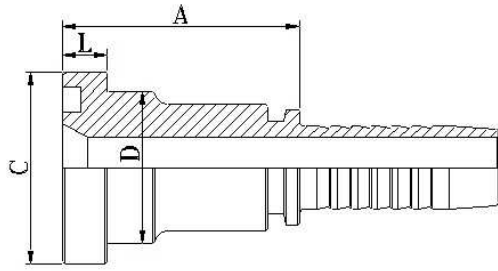

日制法兰 88111

JIS FLANGE

代 号	螺纹 E	软 管		尺 寸				
		公称内径	标 号	A	C	D	L	
88111-10-08	5/8"	12	08	45	34.2	27.8	6.7	
88111-10-10	5/8"	16	10	45.5	34.2	27.8	6.7	
88111-10-12	5/8"	20	12	46	34.2	27.8	6.7	

注: 1.上述代号用于编织软管。 2. 如需用于缠绕软管代号改为 88112-xx-xx。

NOTE : 1. FOR USE WITH BRAIDED HOSES 2. IF USE WITH SPIRAL HOSES , HOSE FITTINGS SERIES NUMBER IS 88112-XX-XX.

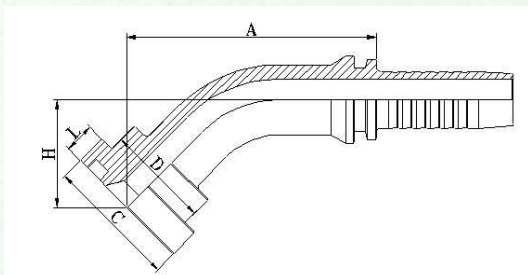

88141

45° 日制法兰  
45° JIS FLANGE

代 号	螺纹 E	软 管		尺 寸				
		公称内径	标 号	A	C	D	H	L
88141-10-08	5/8"	12	08	58.9	34.2	27.8	24	6.7
88141-10-10	5/8"	16	10	69.6	34.2	27.8	25.3	6.7
88141-10-12	5/8"	20	12	76.3	34.2	27.8	28.9	6.7

注: 1.上述代号用于编织软管。 2. 如需用于缠绕软管代号改为 88142-xx-xx。

NOTE : 1. FOR USE WITH BRAIDED HOSES 2. IF USE WITH SPIRAL HOSES , HOSE FITTINGS SERIES NUMBER IS 88142-XX-XX.

# 软管接头 HOSE FITTING

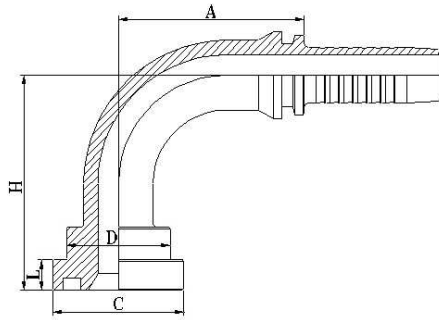

## 88191 90° 日制法兰 90° JIS FLANGE

代 号	螺纹 E	软 管		尺 寸				
		公称内径	标 号	A	C	D	H	L
88191-10-08	5/8"	12	08	41	34.2	27.8	48	6.7
88191-10-10	5/8"	16	10	56	34.2	27.8	52.5	6.7
88191-10-12	5/8"	20	12	66.2	34.2	27.8	62	6.7

注: 1. 上述代号用于编织软管。 2. 如需用于缠绕软管代号改为 88192-xx-xx。

NOTE : 1. FOR USE WITH BRAIDED HOSES 2. IF USE WITH SPIRAL HOSES , HOSE FITTINGS SERIES NUMBER IS 88192-XX-XX.

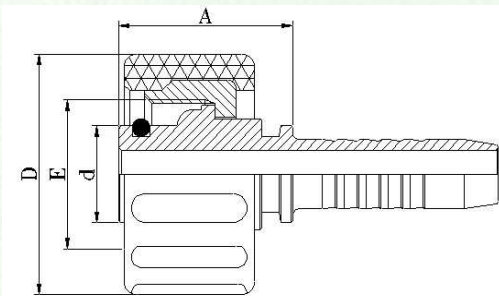

## 20011-ST 公制内螺纹高压水管 METRIC FEMALE WATERWASH INSERTS

代 号	螺纹 E	软 管		尺 寸		
		公称内径	标 号	A	d	D
20011-22-03ST	M22X1.5	5	03	24.5	14	34.5
20011-22-04ST	M22X1.5	6	04	25	14	34.5
20011-22-05ST	M22X1.5	8	05	25	14	34.5
20011-22-06ST	M22X1.5	10	06	25	14	34.5

注: 1. 上述代号用于编织软管。 2. 如需用于缠绕软管代号改为 20012-xx-xx。

NOTE : 1. FOR USE WITH BRAIDED HOSES 2. IF USE WITH SPIRAL HOSES , HOSE FITTINGS SERIES NUMBER IS 20012-XX-XX.



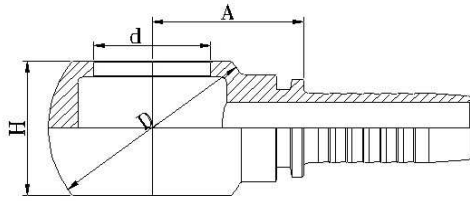

70011  
公制铰接体  
METRIC BANJO  
DIN 7642

代 号	螺纹 E	软 管		尺 寸			
		公称内径	标 号	A	d	D	H
70011-10-03	M10X1	5	03	14.5	10.1	17	10
70011-10-04	M10X1	6	04	17	10.1	17	10
70011-12-04	M12X1.5	6	04	20.5	12.1	20	12
70011-12-05	M12X1.5	8	05	20.5	12.1	20	12
70011-12-06	M12X1.5	10	06	20.5	12.1	20	12
70011-14-04	M14X1.5	6	04	19	14.1	24	14
70011-14-05	M14X1.5	8	05	19	14.1	24	14
70011-14-06	M14X1.5	10	06	21	14.1	24	14
70011-16-04	M16X1.5	6	04	20.5	16.1	28	16
70011-16-05	M16X1.5	8	05	20.5	16.1	28	16
70011-16-06	M16X1.5	10	06	20.5	16.1	28	16
70011-18-04	M18X1.5	6	04	23	18.1	32	20
70011-18-05	M18X1.5	8	05	24	18.1	32	20
70011-18-06	M18X1.5	10	06	24	18.1	32	20
70011-18-08	M18X1.5	12	08	24.5	18.1	32	20
70011-22-06	M22X1.5	10	06	28.1	22.1	39	25
70011-22-08	M22X1.5	12	08	28.5	22.1	39	25
70011-22-10	M22X1.5	16	10	27.5	22.1	39	25
70011-26-12	M26X1.5	20	12	30.5	26.1	46	30
70011-30-16	M30X1.5	25	16	37	30.1	54	36
70011-30-20	M30X1.5	32	20	41	30.1	54	36

注: 1.上述代号用于编织软管。 2. 如需用于缠绕软管代号改为 70012-xx-xx。

NOTE : 1. FOR USE WITH BRAIDED HOSES 2. IF USE WITH SPIRAL HOSES , HOSE FITTINGS SERIES NUMBER IS 70012-XX-XX.



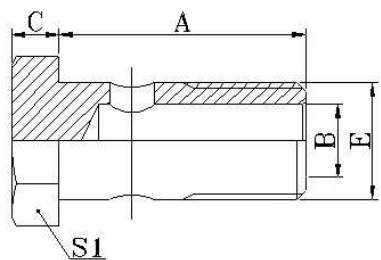

**700M**  
公制铰接螺栓  
**METRIC BOLT**  
DIN 7643

代 号	螺纹 E	尺 寸			
		A	B	C	S1
700M-10	M10X1	19	4	6	14
700M-12	M12X1.5	24	6	6	17
700M-14	M14X1.5	26	8	7	19
700M-16	M16X1.5	28	9	7.5	22
700M-18	M18X1.5	32	11	8	24
700M-22	M22X1.5	39	14	9	27
700M-26	M26X1.5	45	18	10	32
700M-30	M30X1.5	51	22	11	36

# 软管接头 HOSE FITTING

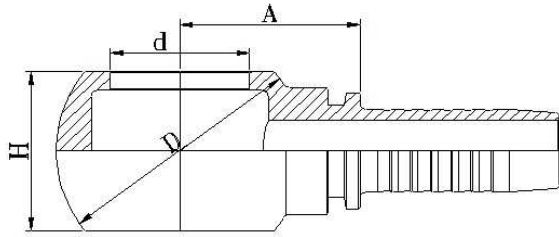

## 72011 英制铰接体 BSP BANJO

代 号	螺 纹 E	软 管		尺 寸			
		公称内径	标 号	A	d	D	H
72011-02-03	G1/8"X28	5	03	18	9.9	24	16
72011-02-04	G1/8"X28	6	04	18.5	9.9	24	16
72011-04-03	G1/4"X19	5	03	19	13.3	24	15
72011-04-04	G1/4"X19	6	04	19.5	13.3	24	15
72011-04-05	G1/4"X19	8	05	19.5	13.3	24	15
72011-04-06	G1/4"X19	10	06	19.5	13.3	24	15
72011-06-04	G3/8"X19	6	04	22	16.7	29	20
72011-06-05	G3/8"X19	8	05	22	16.7	29	20
72011-06-06	G3/8"X19	10	06	22	16.7	29	20
72011-06-08	G3/8"X19	12	08	23	16.7	29	20
72011-08-05	G1/2"X14	8	05	27.5	21	38	25
72011-08-06	G1/2"X14	10	06	27.5	21	38	25
72011-08-08	G1/2"X14	12	08	28	21	38	25
72011-08-10	G1/2"X14	16	10	29	21	38	25
72011-10-10	G5/8"X14	16	10	28	23	40	27
72011-12-10	G3/4"X14	16	10	32	26.5	48	31
72011-12-12	G3/4"X14	20	12	32	26.5	48	31
72011-16-08	G1"X11	12	08	40	33.3	60	42
72011-16-12	G1"X11	20	12	40	33.3	60	42
72011-16-16	G1"X11	25	16	41	33.3	60	42

注: 1.上述代号用于编织软管。 2. 如需用于缠绕软管代号改为 72012-xx-xx。

NOTE : 1. FOR USE WITH BRAIDED HOSES 2. IF USE WITH SPIRAL HOSES , HOSE FITTINGS SERIES NUMBER IS 72012-XX-XX.

# 软管接头 HOSE FITTING

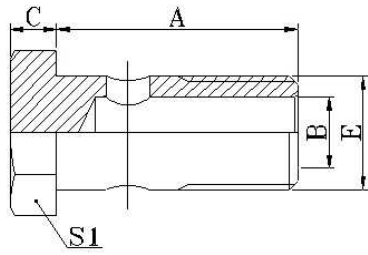

**720B**

英制铰接螺栓

**BSP BOLT**

代 号	螺 纹 E	尺 寸					
		A	B	C	S1		
720B-02	G1/8"X28	29.5	4.8	4.8	14		
720B-04	G1/4"X19	28.5	6	6	19		
720B-06	G3/8"X19	38.5	9	7	22		
720B-08	G1/2"X14	44	13	8.5	27		
720B-10	G5/8"X14	48.5	15	10	30		
720B-12	G3/4"X14	56	18	10	32		
720B-16	G1"X11	68.5	22	13	41		

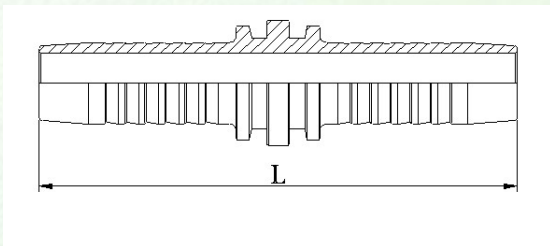

**90011**

双面连接芯

**DOUBLE CONNECTOR**

代 号	软 管		尺 寸			
	公称内径	标 号	L			
90011-04	6	04	69			
90011-05	8	05	69			
90011-06	10	06	73			
90011-08	12	08	77			
90011-10	16	10	89			
90011-12	20	12	96			
90011-16	25	16	114			
90011-20	32	20	132			
90011-24	40	24	162			
90011-32	50	32	170			

注: 用于编织软管. NOTE:FOR WIRE BRAID HOSE.

90012

双面连接芯

DOUBLE CONNECTOR

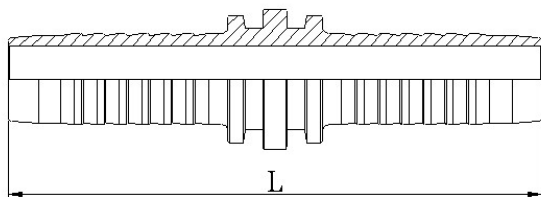

代 号	软 管		尺 寸			
	公称内径	标 号		L		
90012-04	6	04		83		
90012-05	8	05		87		
90012-06	10	06		87		
90012-08	12	08		91		
90012-10	16	10		97		
90012-12	20	12		111		
90012-16	25	16		134		
90012-20	32	20		153		
90012-24	40	24		172		
90012-32	50	32		178		

注:用于缠绕软管. NOTE:FOR SPRIAL HOSE.

### Hebei Qianli Rubber Products Co., Ltd.

Add: West Side of Yafu Road, Jingxian County, Hengshui City, Hebei, China

Tel: +86-318-6668206

Fax: +86-318-6668207

WhatsApp: +86-15175488989

Skype: Roxphild Lee

E-mail: rox@hebeiqianli.com

<https://www.hydraulicchse-fittings.com>